

KORKOR TOON
Kids Learning Books

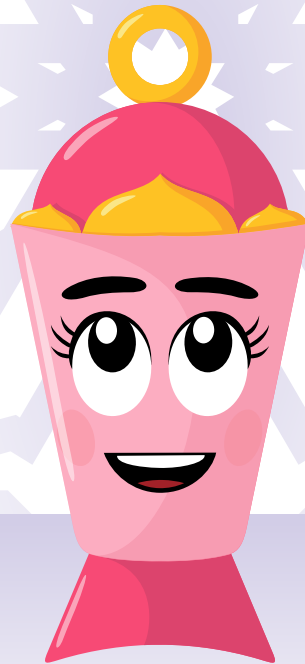

كتاب أنشطة

رمضان



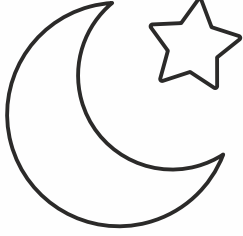

كتاب أنشطة
رمضان



A large rectangular box with a dashed line for writing, intended for a child's activity or drawing. The box has four black dots at the corners, suggesting it's a page from a book. The dashed line is positioned in the upper half of the box, leaving space for a drawing or illustration below it.

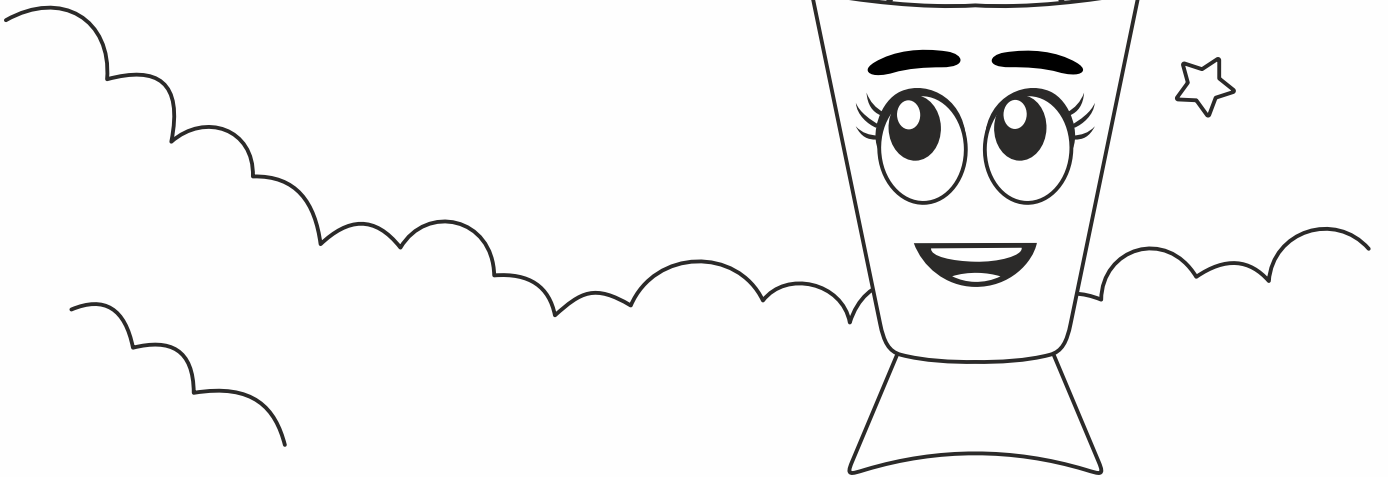

خطة رمضان

جدول المهام اليومية في شهر رمضان

اليوم	صلاة	صيام	قرآن	دعاء	صدقة
١					
٢					
٣					
٤					
٥					
٦					
٧					
٨					
٩					
١٠					
١١					
١٢					
١٣					
١٤					
١٥					

خطة رمضان

جدول المهام اليومية في شهر رمضان

اليوم	صلاة	صيام	قرآن	دعاء	صدقة
١٦					
١٧					
١٨					
١٩					
٢٠					
٢١					
٢٢					
٢٣					
٢٤					
٢٥					
٢٦					
٢٧					
٢٨					
٢٩					
٣٠					

المتاهة

ساعد صديقتنا للوصول إلى المسجد عبر المتاهة

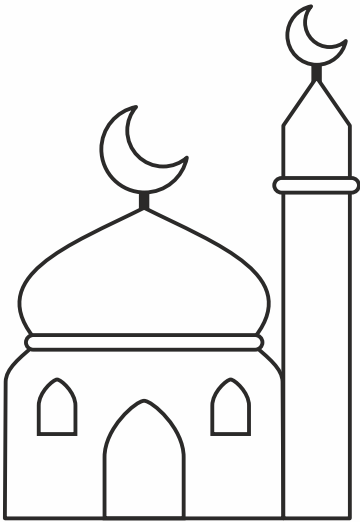
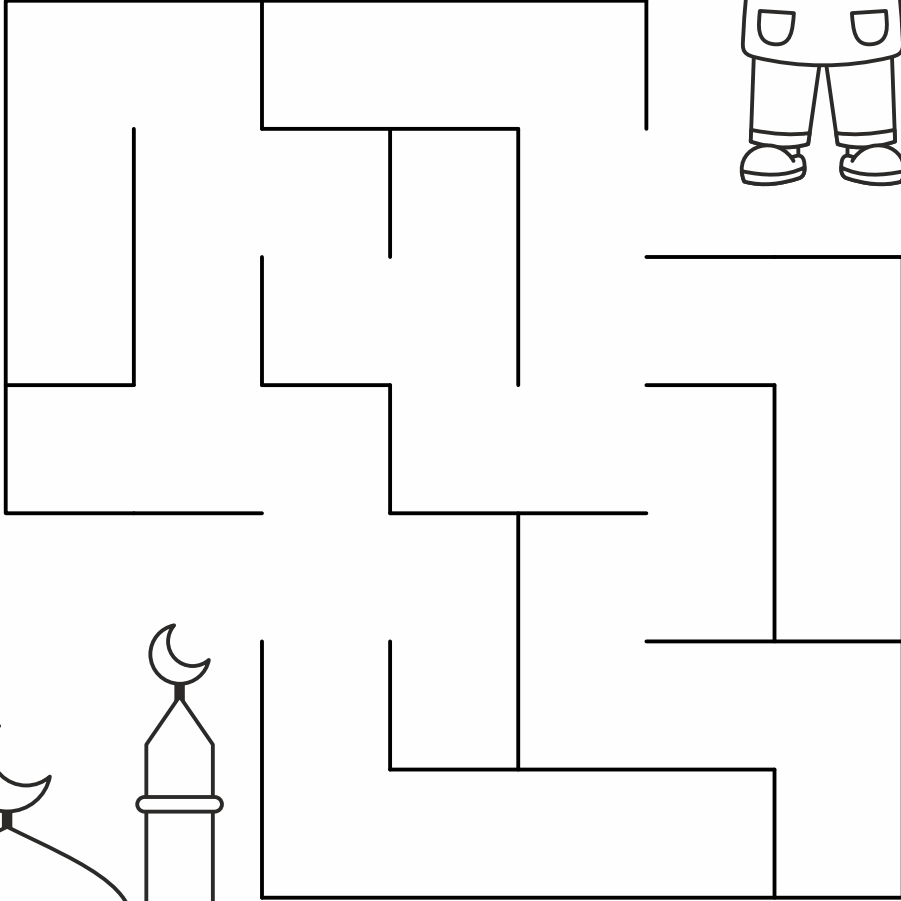
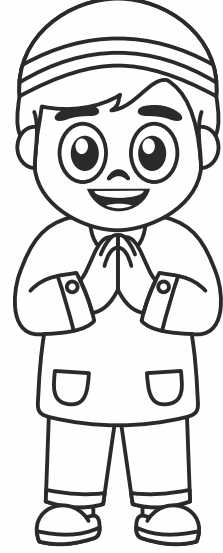

الصورة المختلفة

ارسم دائرة حول الصورة المختلفة لكل مجموعة

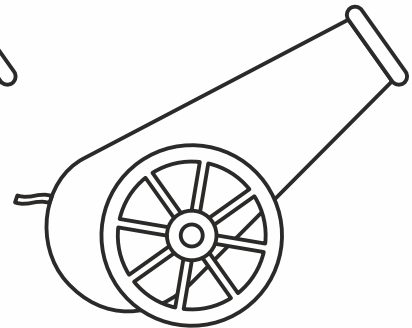
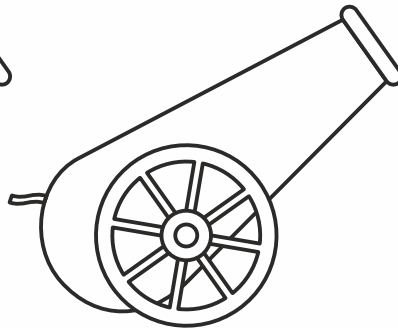
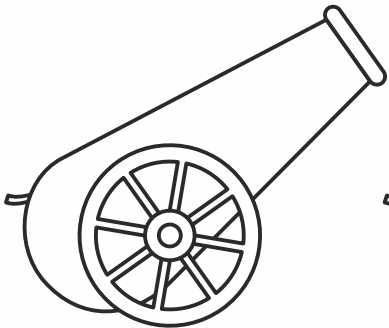

الاختلافات



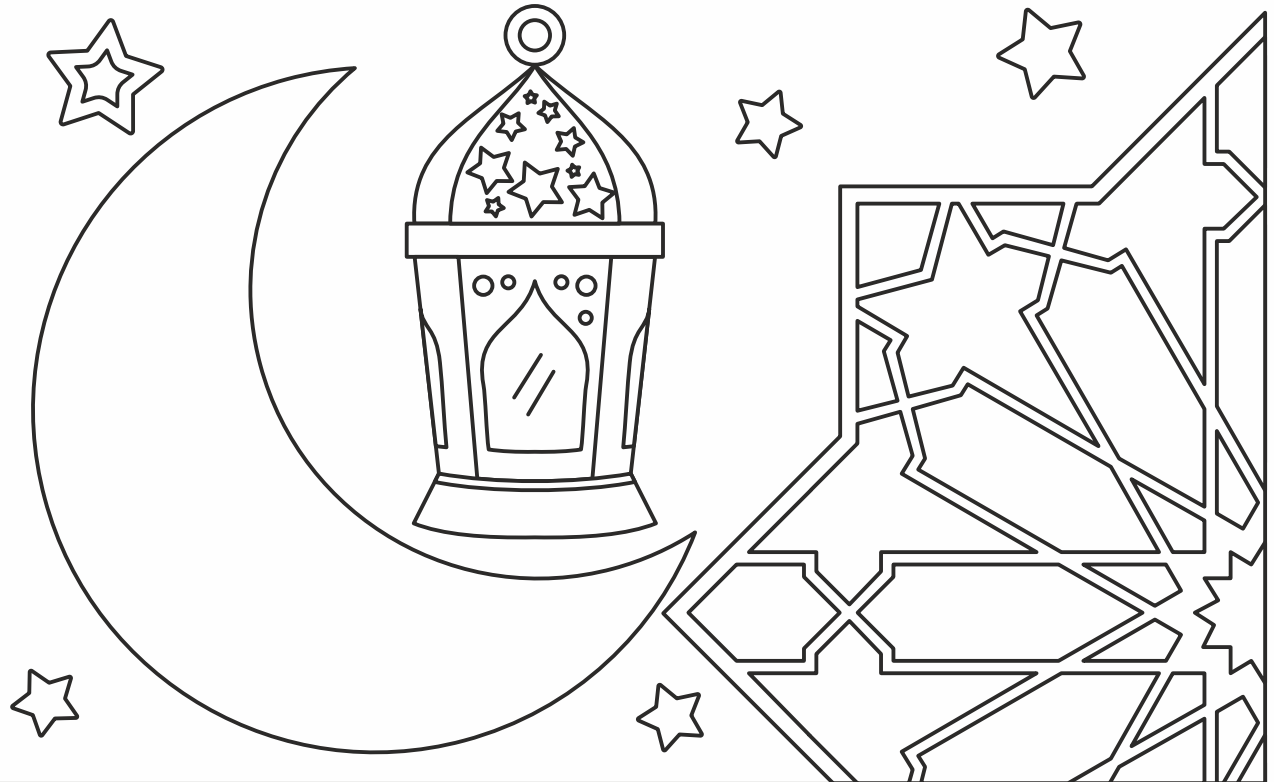
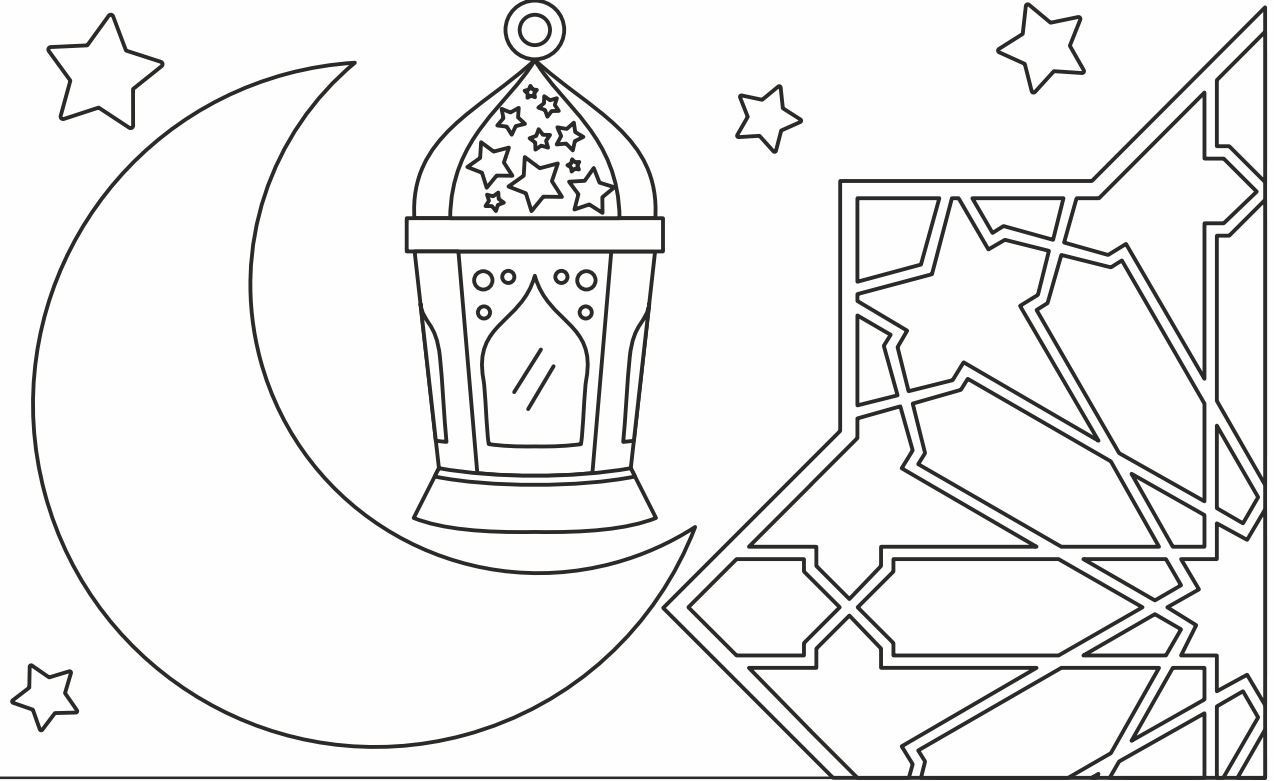

حدد الاختلافات الخمسة بين الصورتين

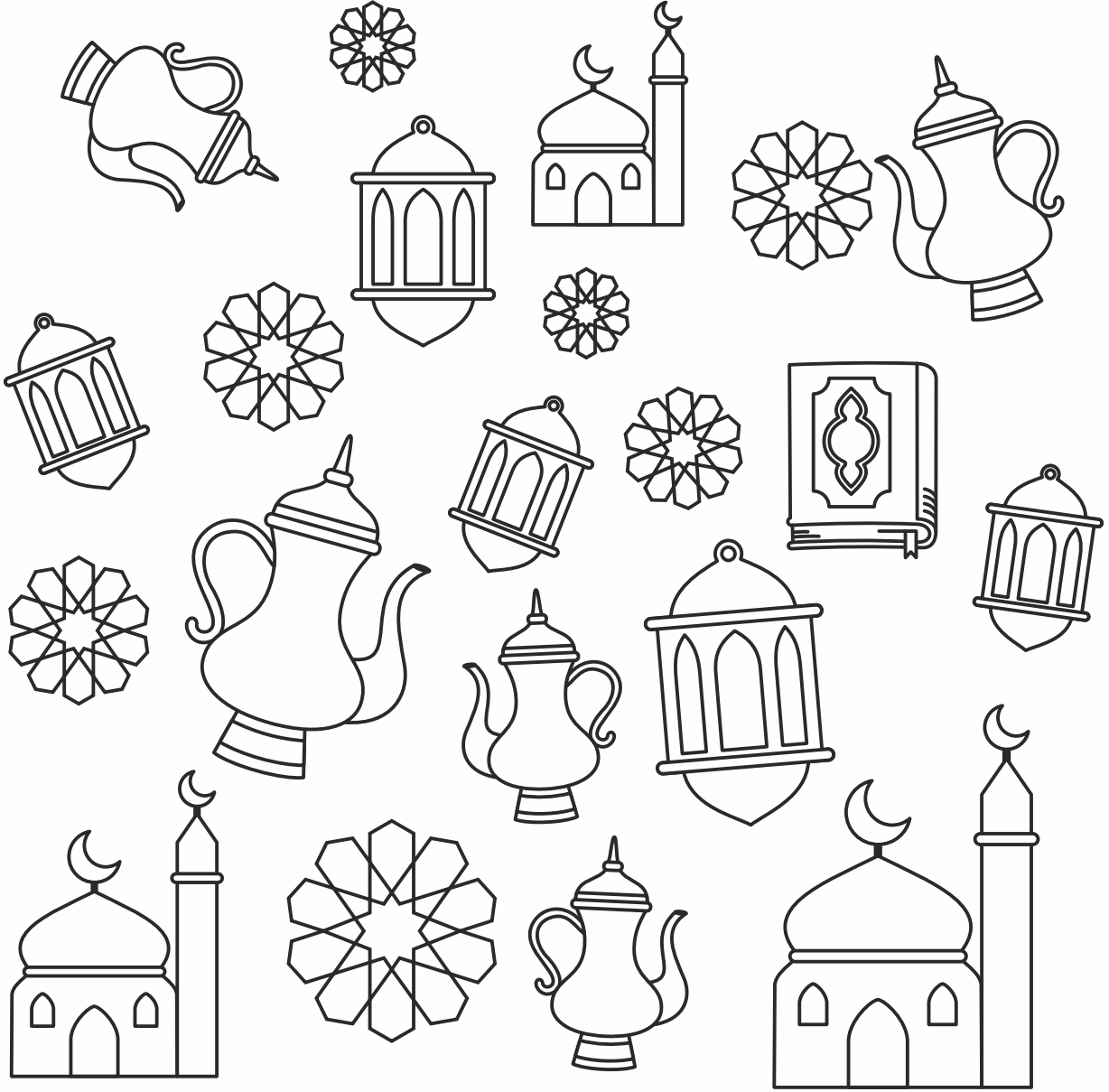

إِجْمَع و لُون

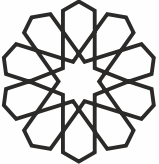
اكتب عدد كل صورة



				
--	--	--	---	--

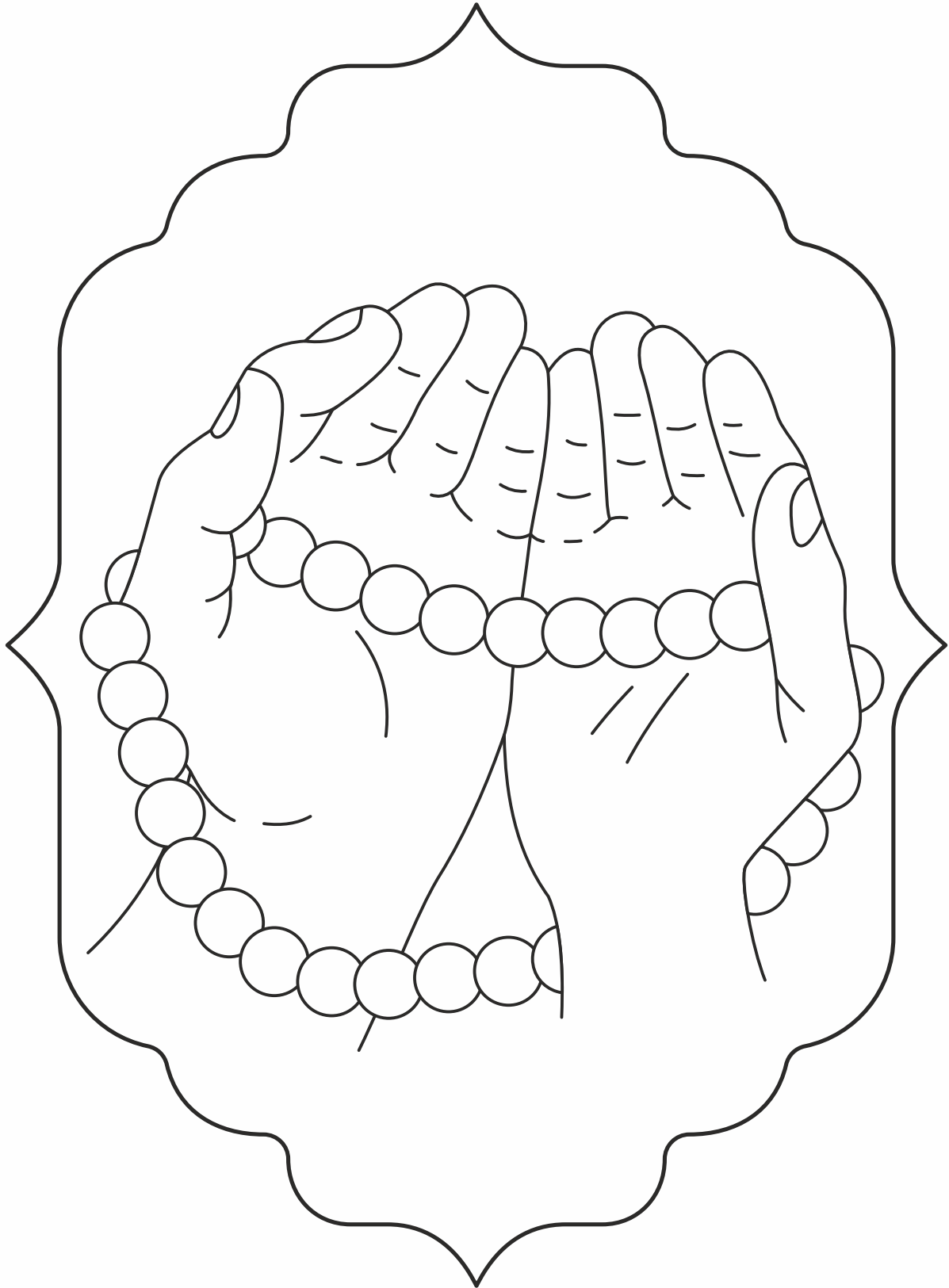

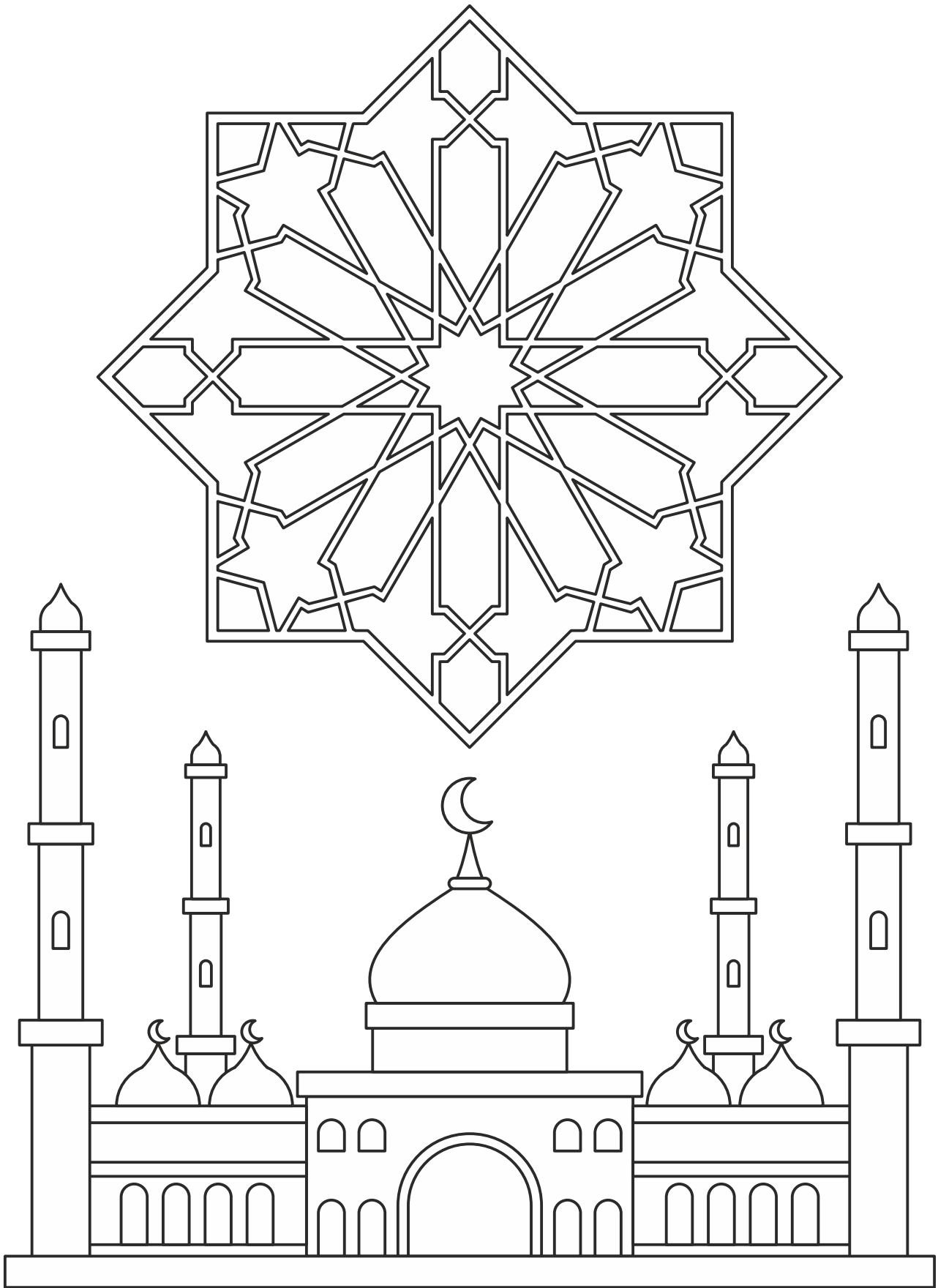

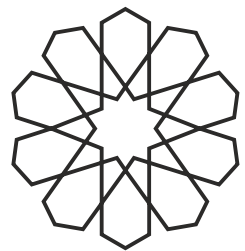
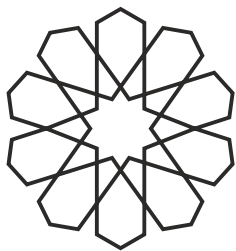
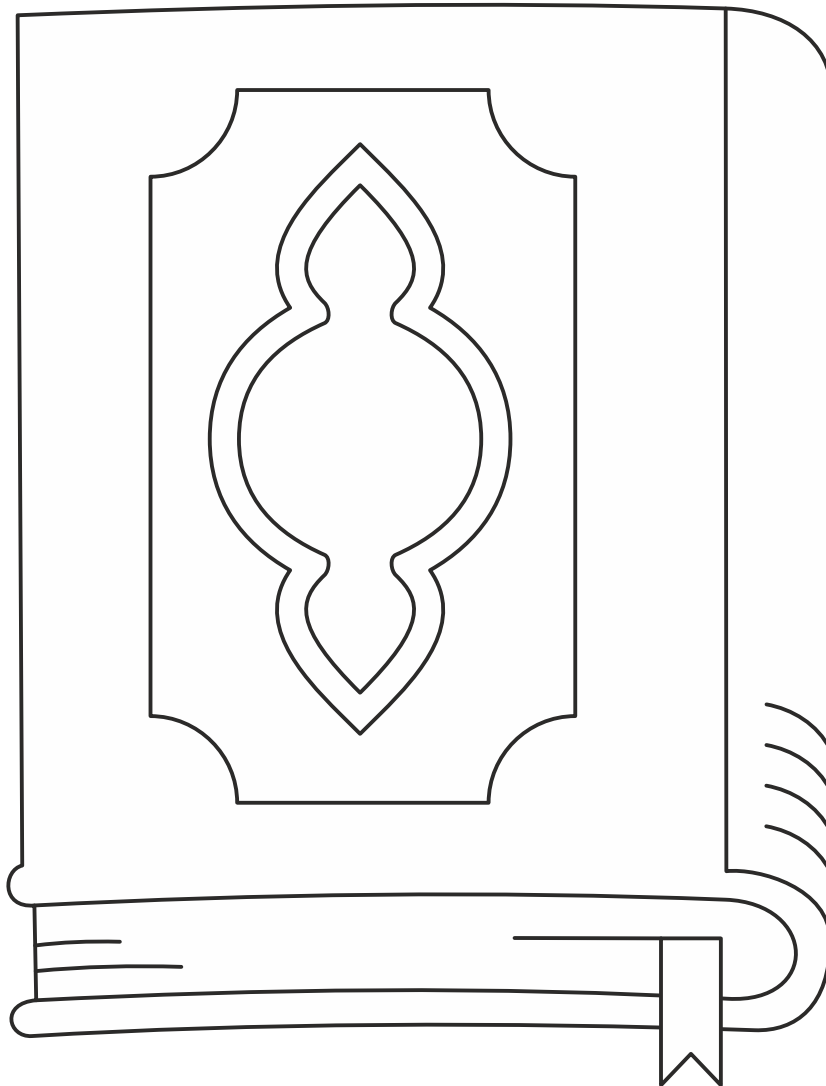
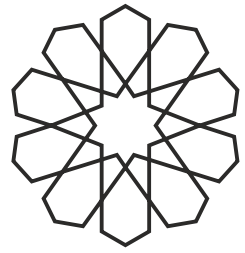
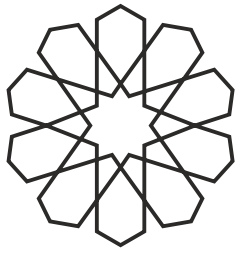

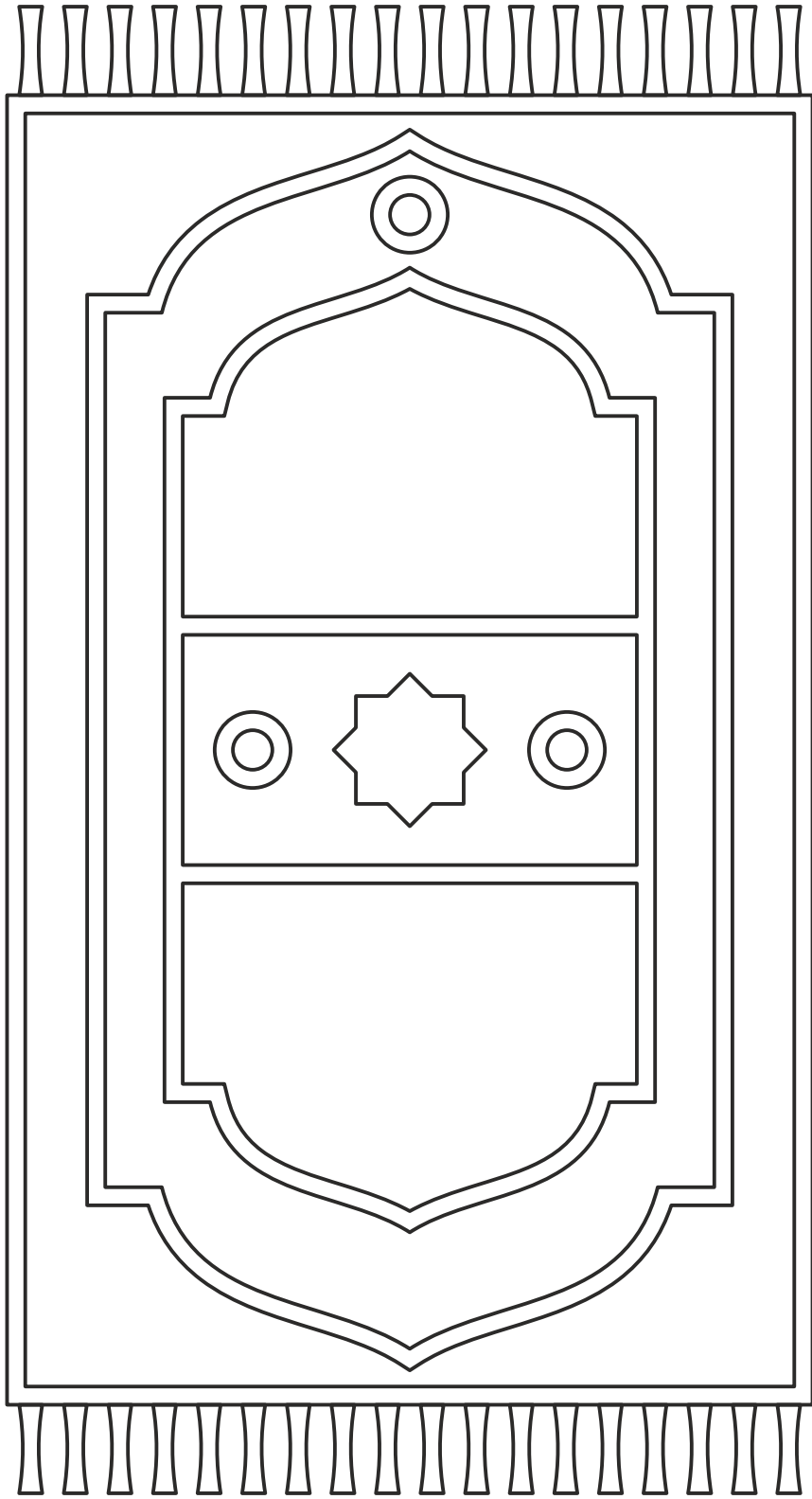

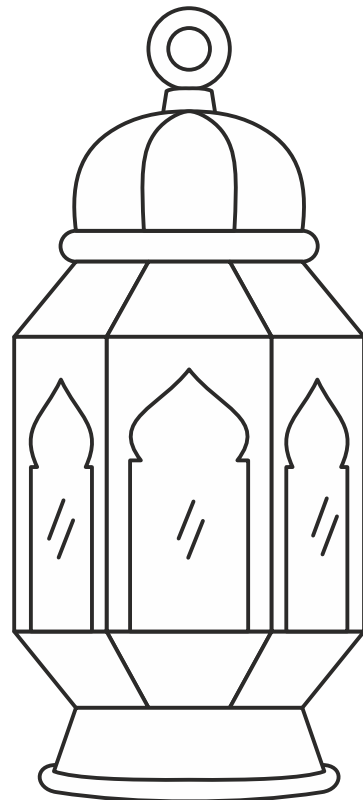
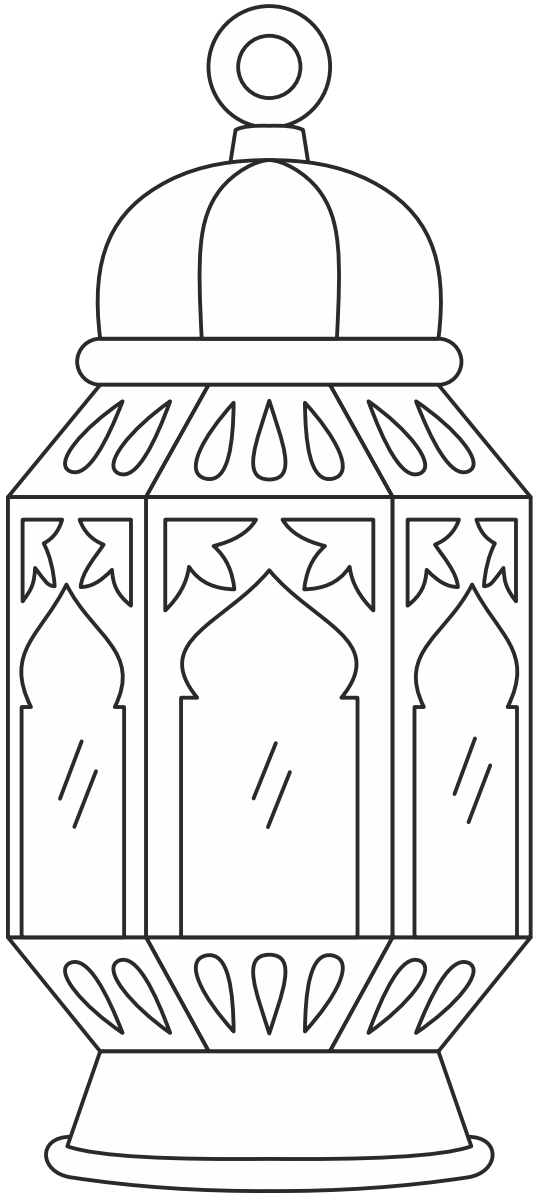
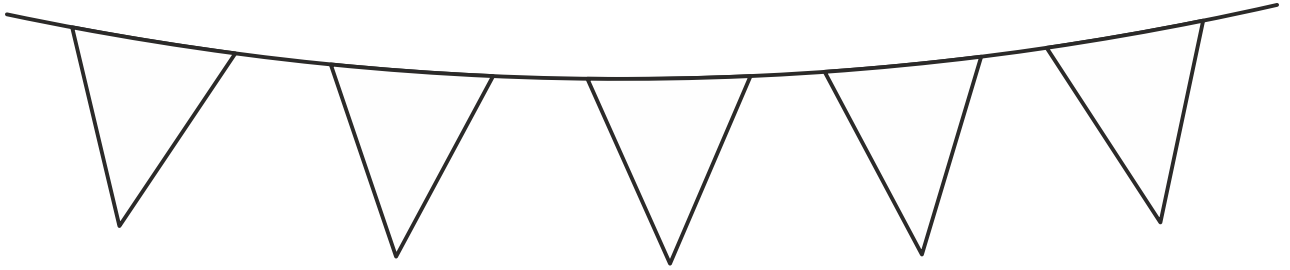

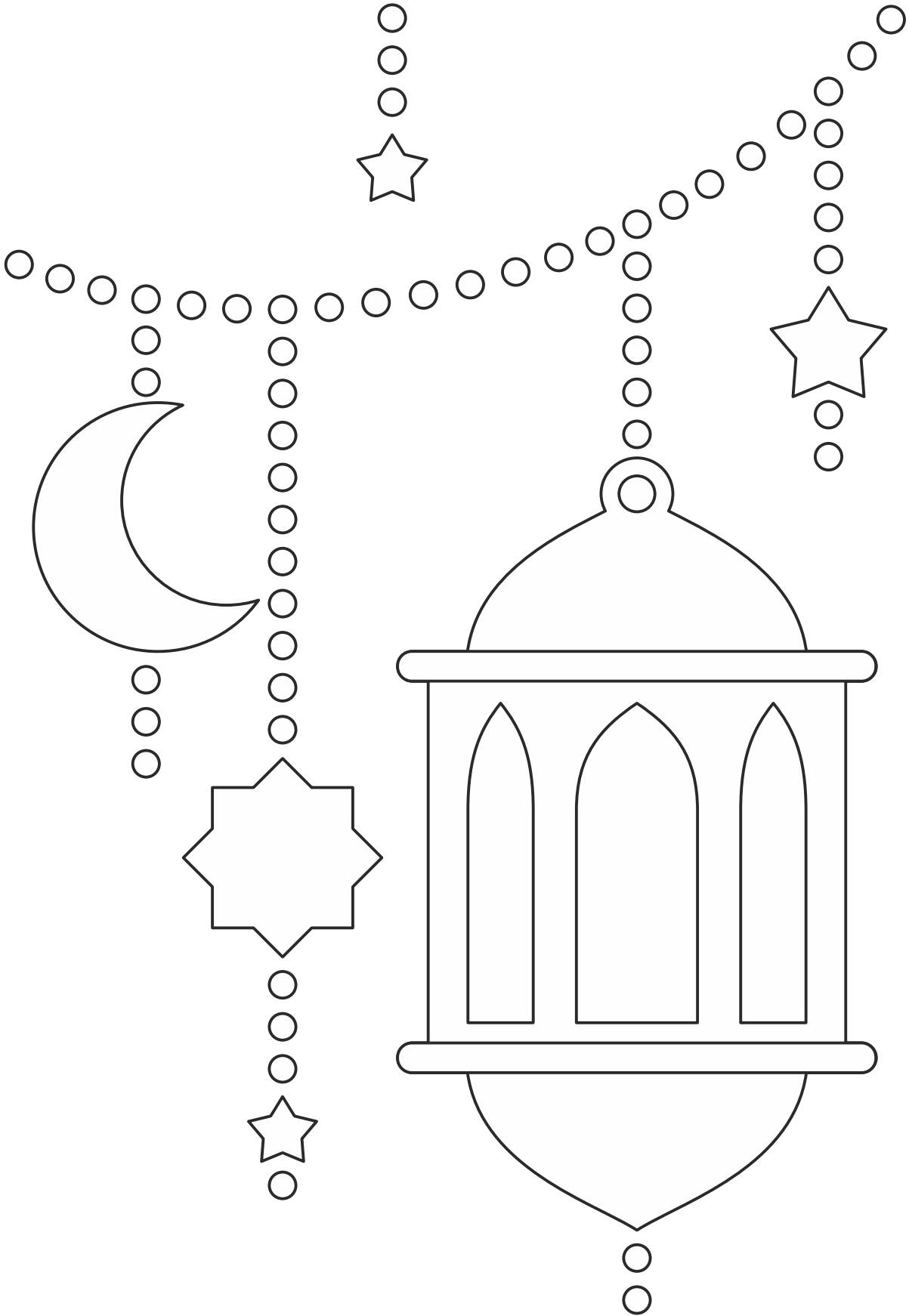

رمضان كريم

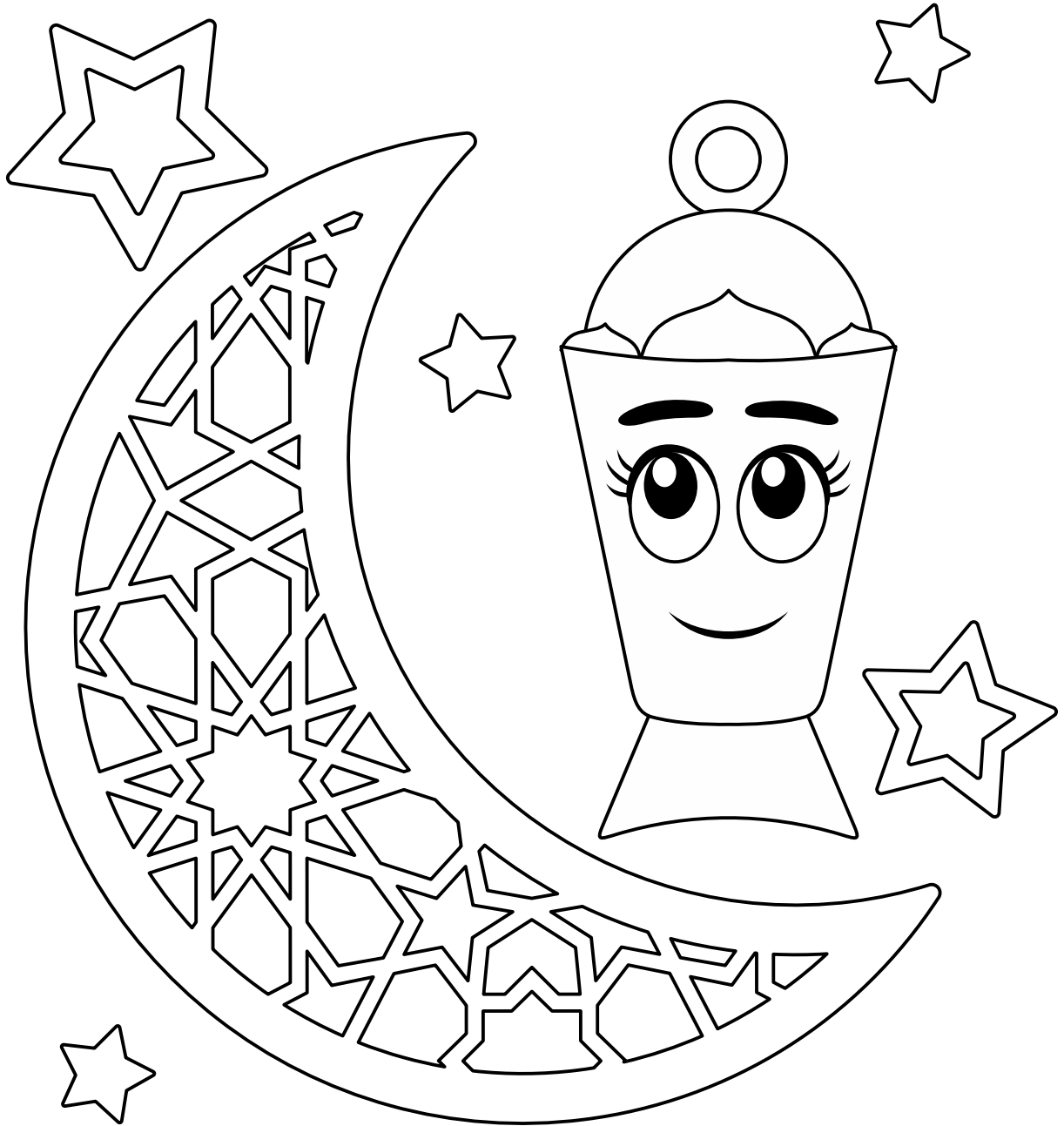

المتاهة

قمر بتوصيل الإبريق بطبق التمر عبر المتاهة لتحضير الإفطار

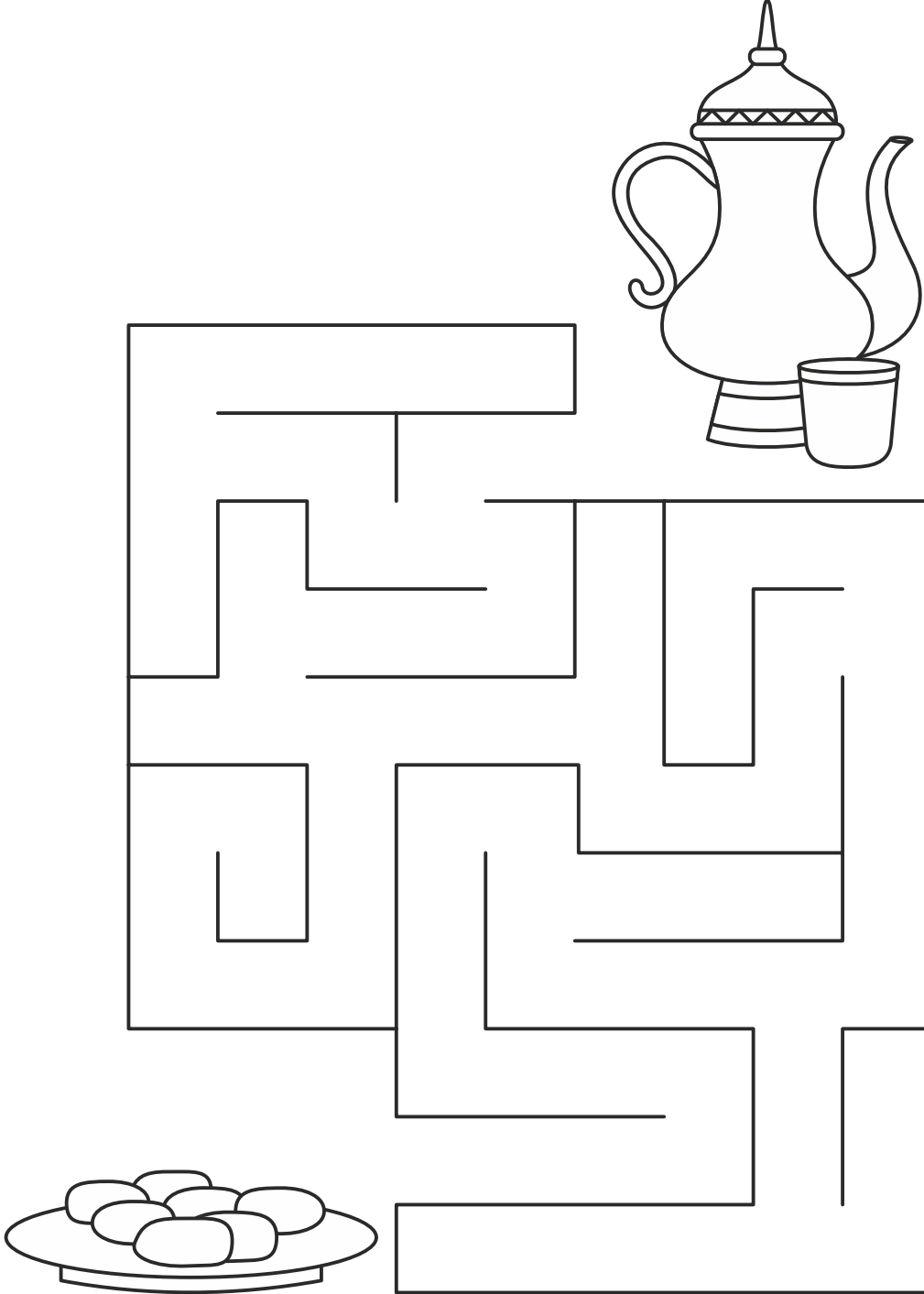

المتاهة

قم بتوصيل الشمعة للفانوس عبر المتاهة

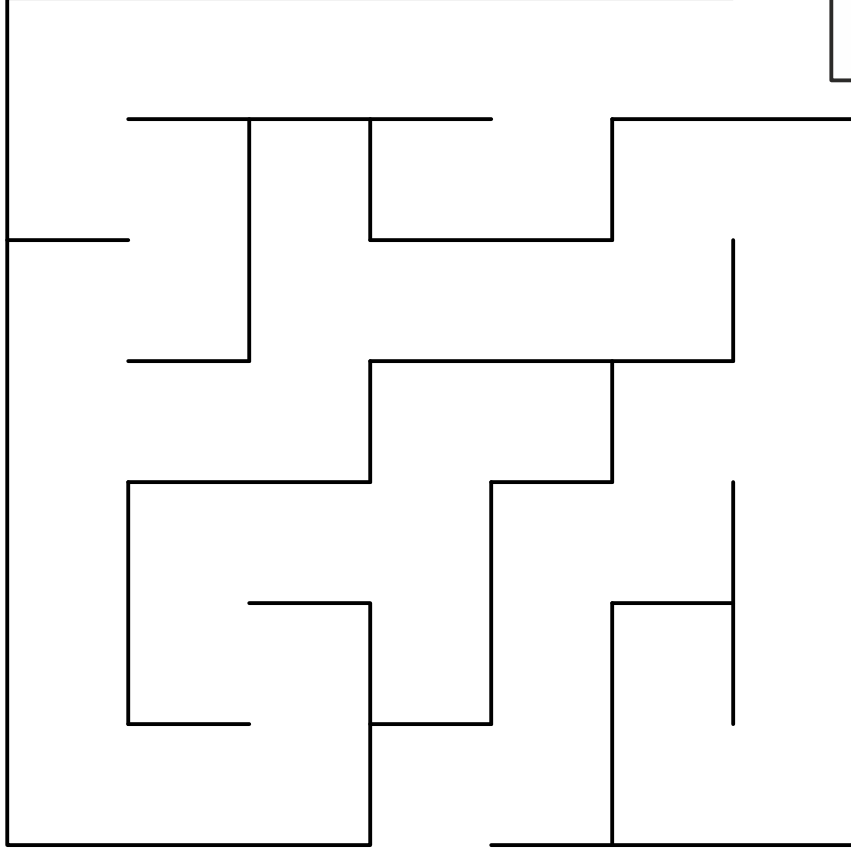

الصورة المختلفة

ارسم دائرة حول الصورة المختلفة لكل مجموعة

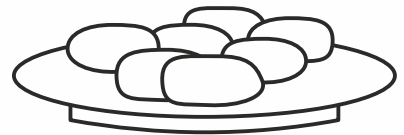
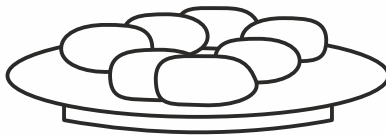
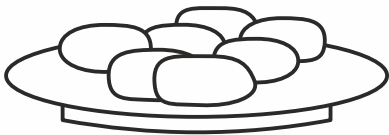
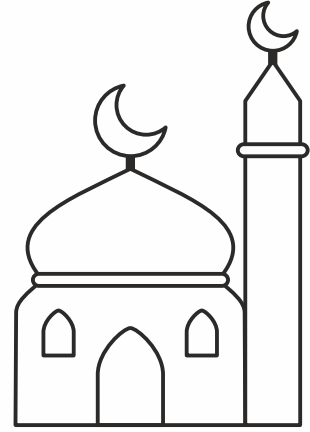
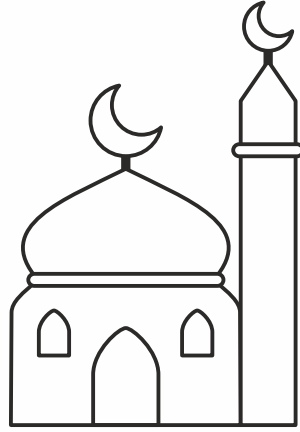
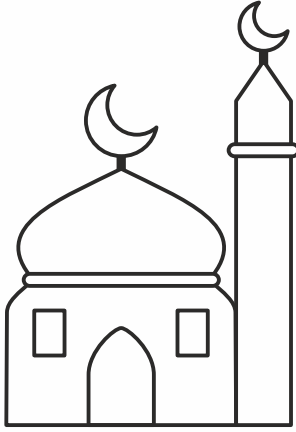
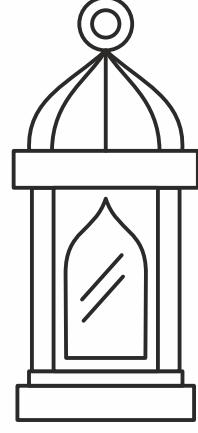
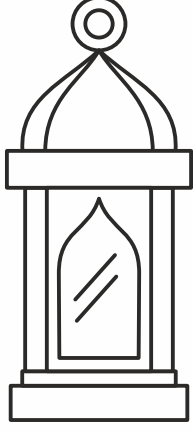
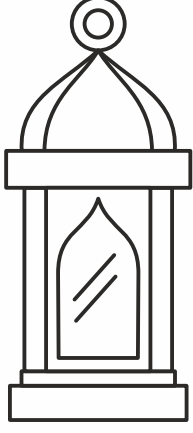

الاختلافات

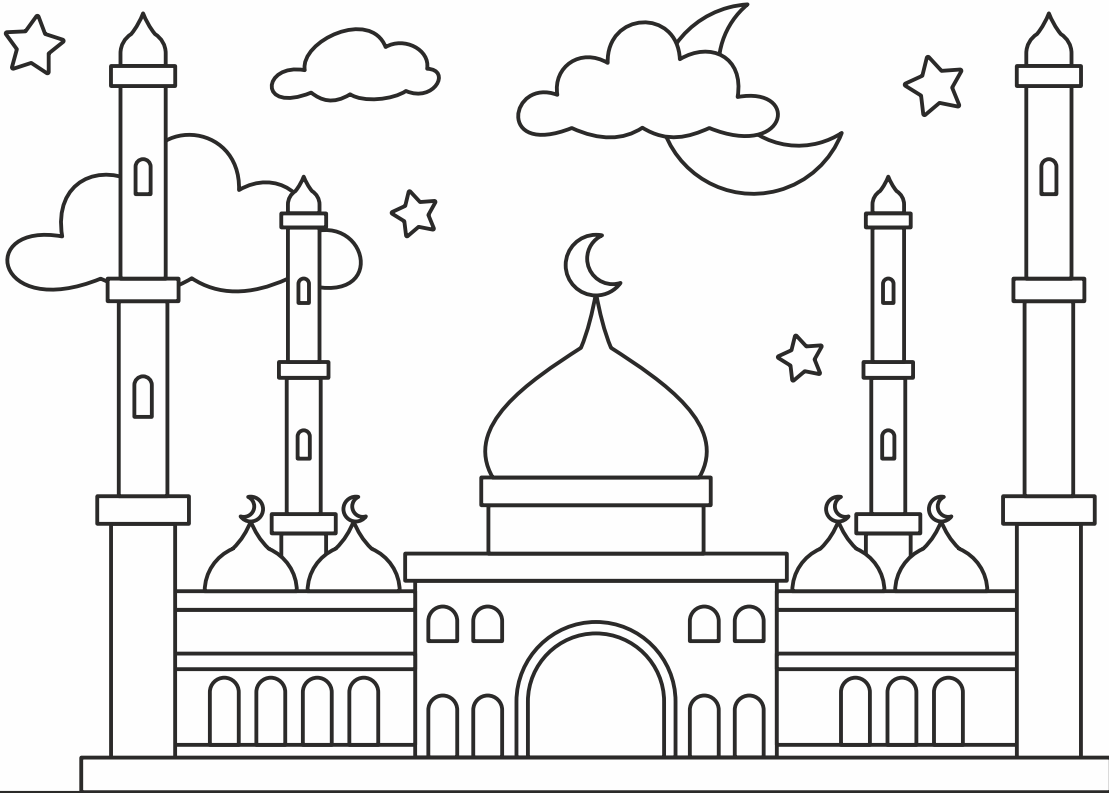
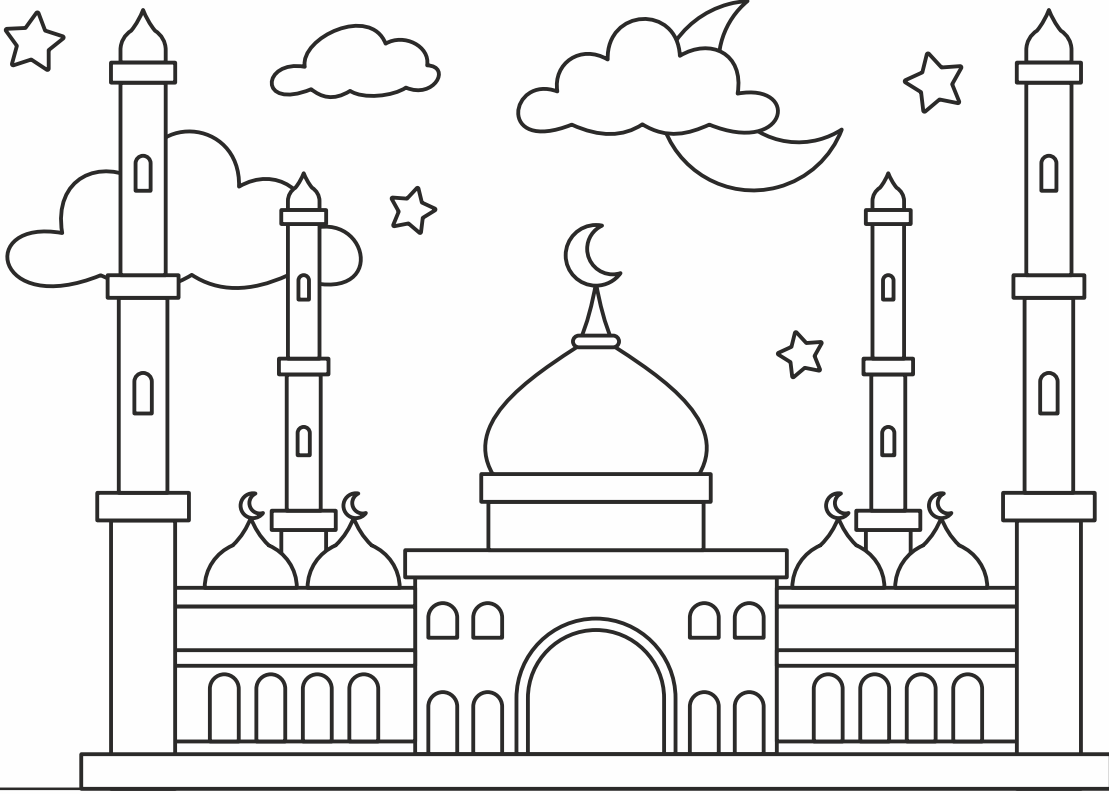

حدد الاختلافات الخمسة بين الصورتين



إِجْمَع و لُون

اكتب عدد كل صورة

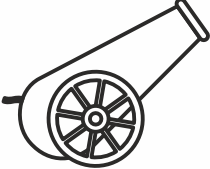

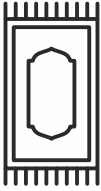
				
--	--	--	---	--

ابحث عن الكلمات

حوظ الحروف التي تشكل الكلمات المحددة

أ	ب	س	ن	ي	ش	ج	ك	ف
خ	ص	ح	إ	ف	ط	ا	ر	غ
هـ	ج	و	م	ا	ن	ت	م	ر
ي	ق	ر	آ	ن	ا	ر	د	ب
ل	فا	س	ض	و	ض	ا	س	م
ت	ع	د	ج	س	م	و	ص	ي
ا	ش	ز	ن	ص	ر	ي	ل	ت
ق	هـ	ل	ا	ل	ك	ح	ا	هـ
ث	ر	ج	ف	ز	ك	ا	ة	ظ

سحور

فانوس

شهر

إفطار

رمضان

تمر

بدر

هلال

زكاة

صوم

قرآن

فجر

تراويح

صلاة

مسجد

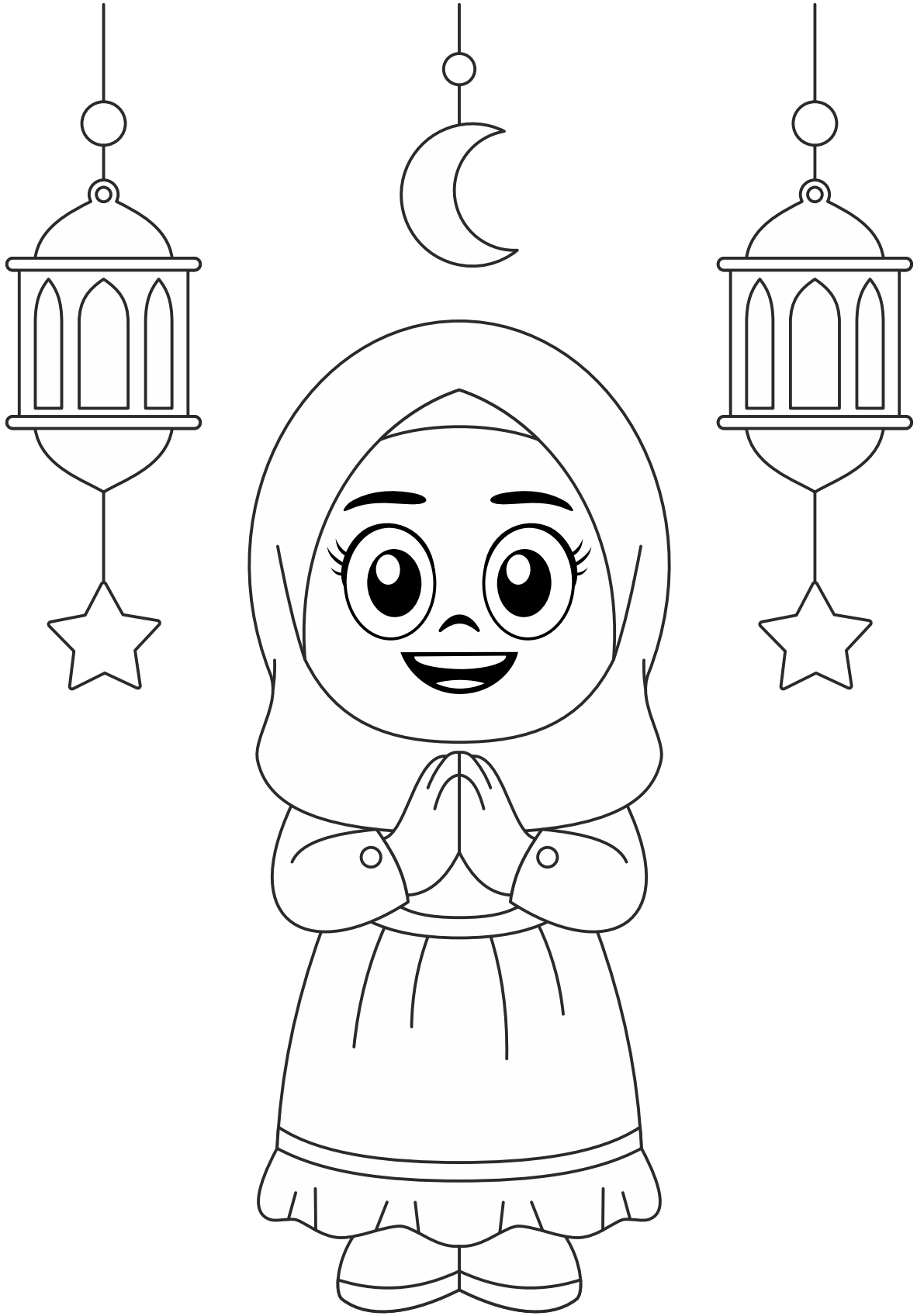

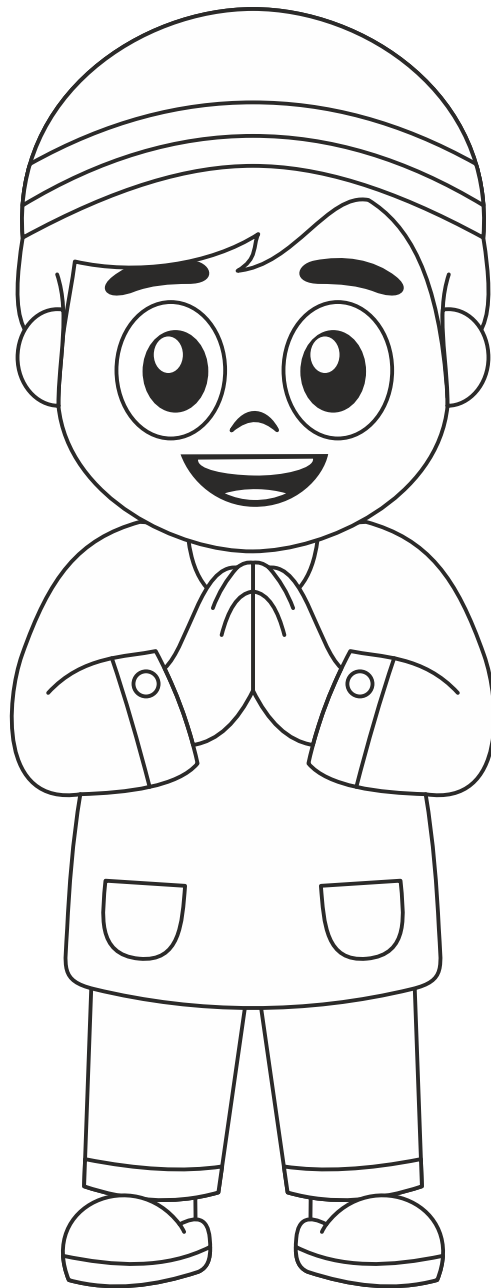
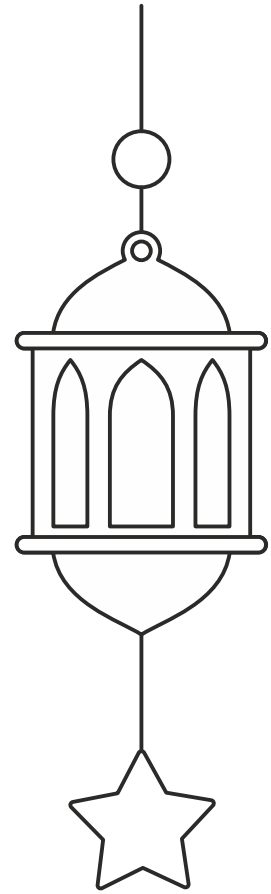
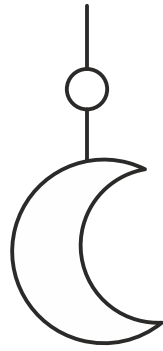
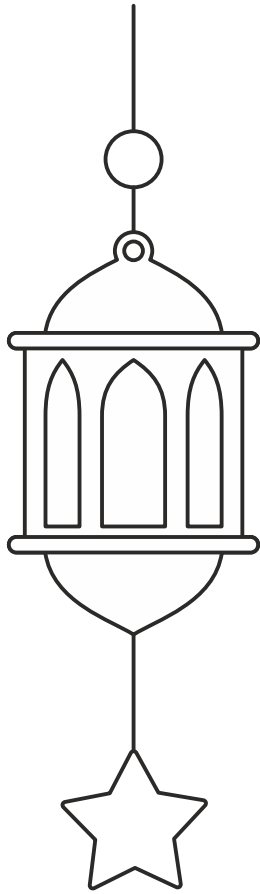

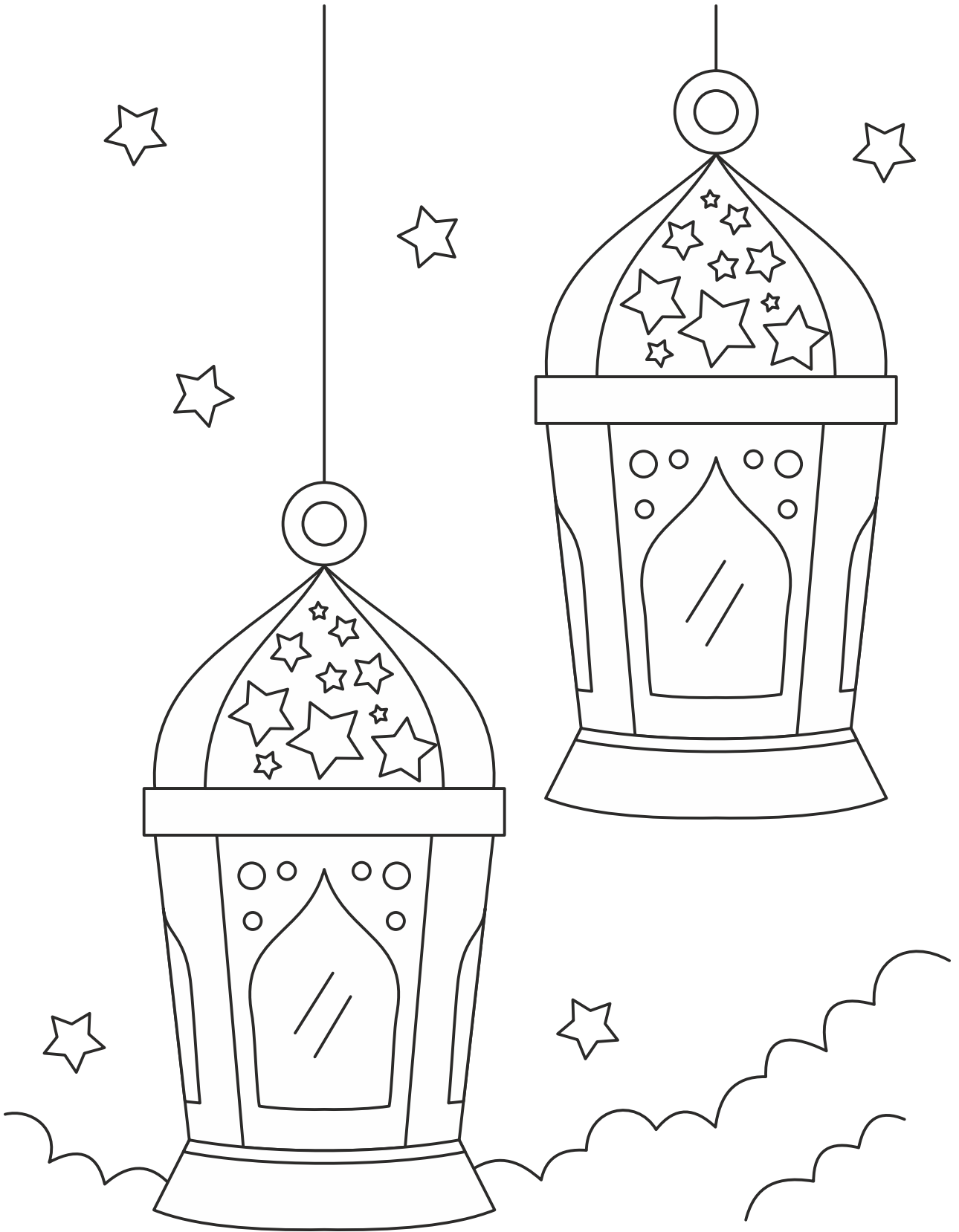



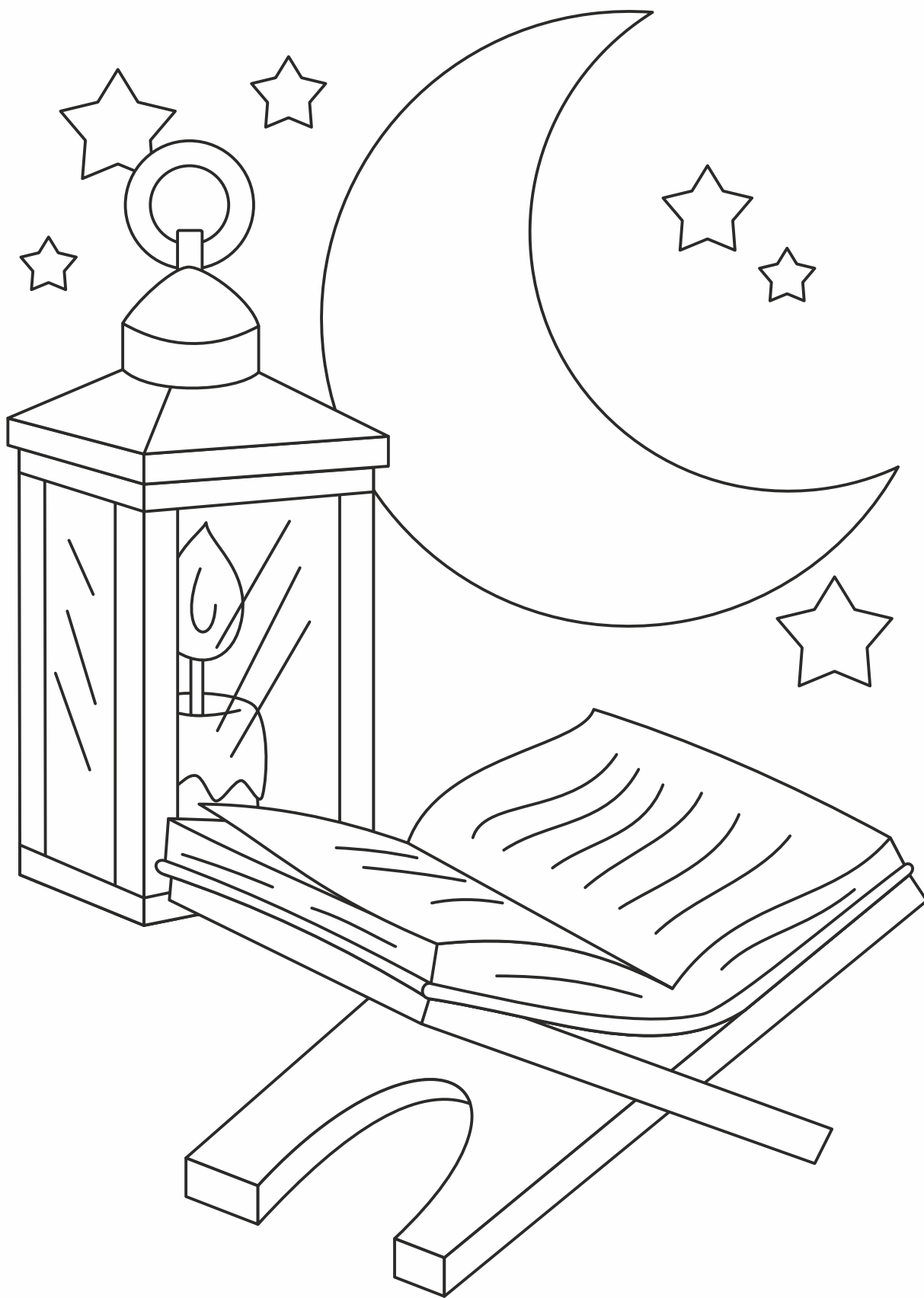

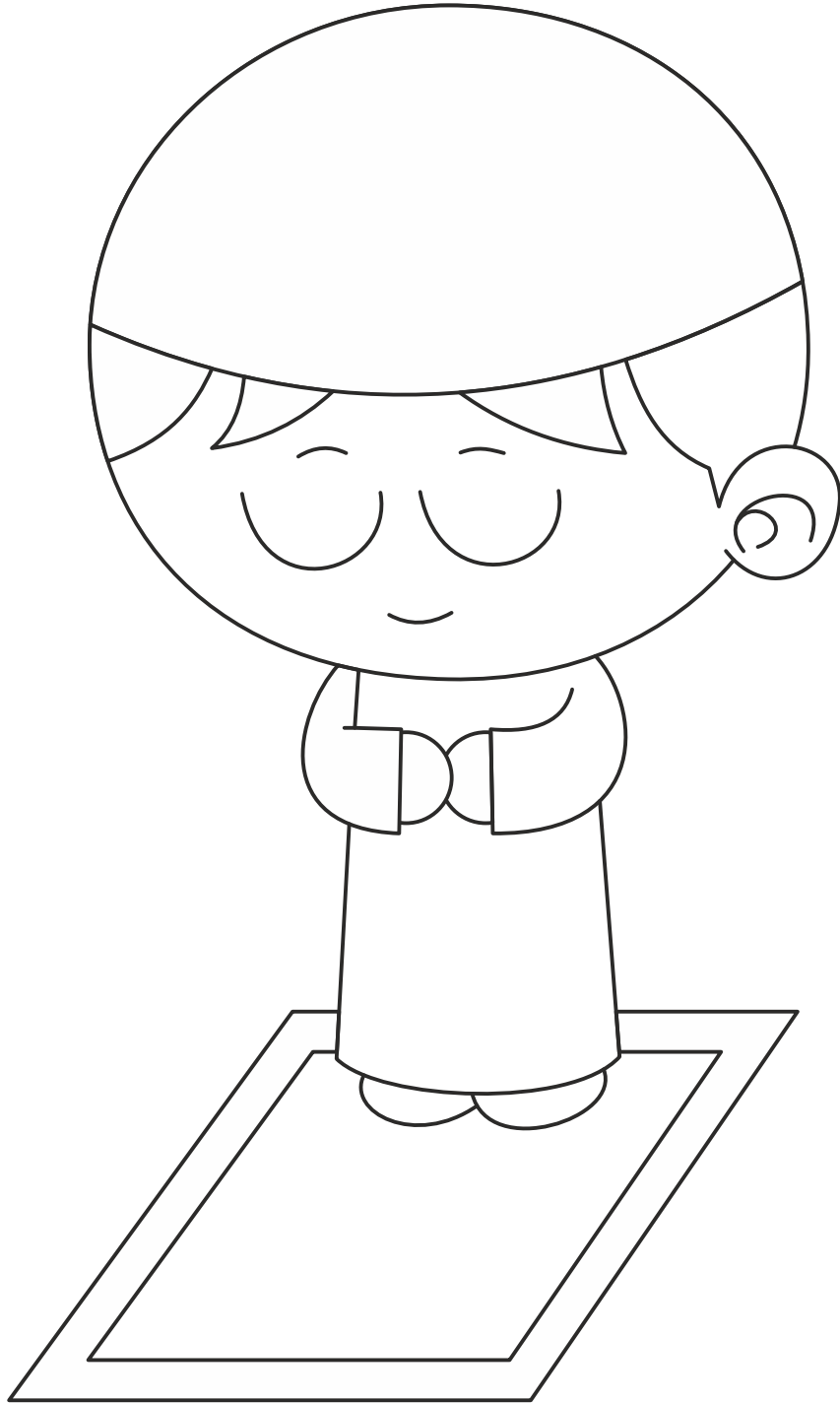

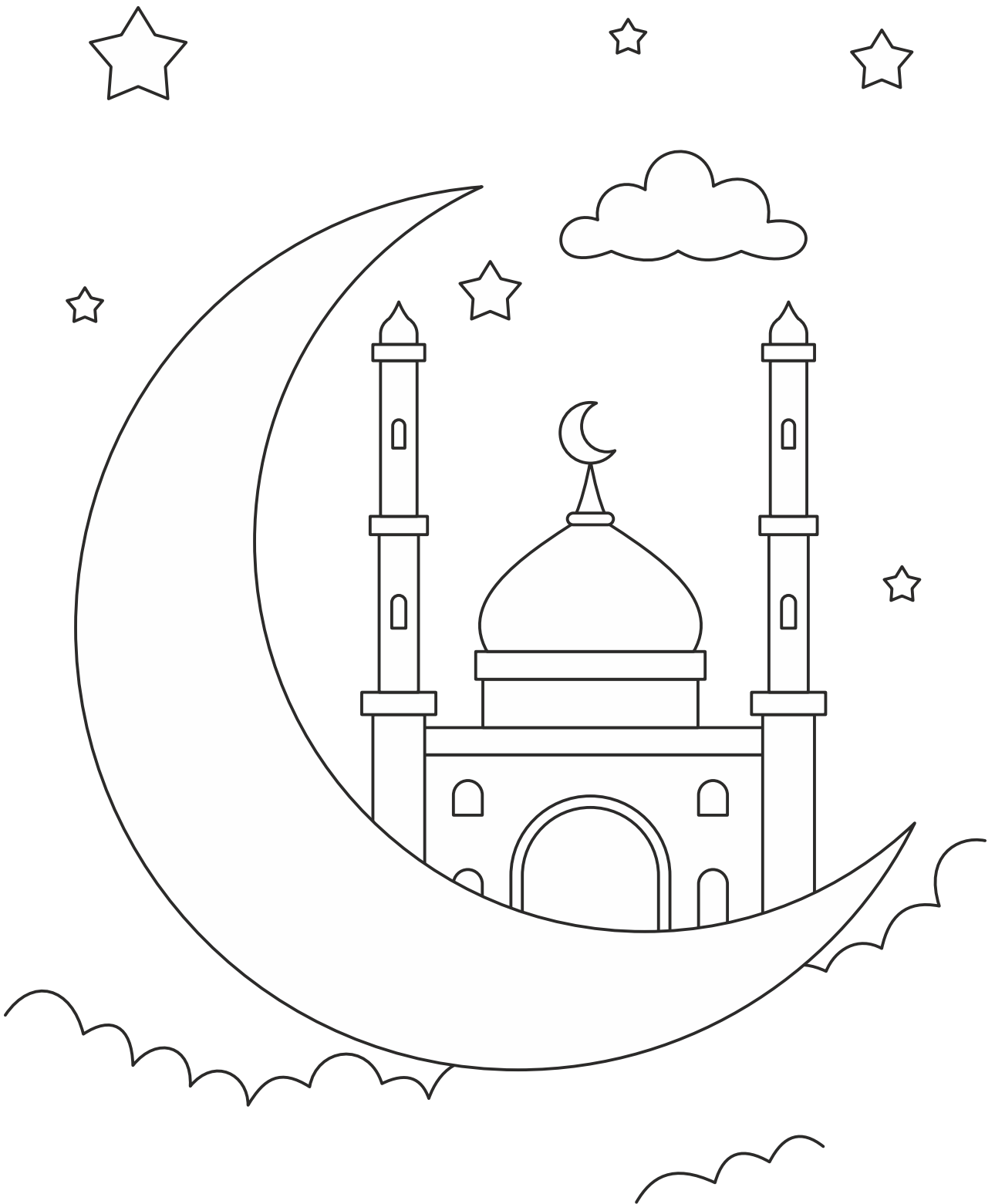

قوالب زينة رمضان

لون ثم قص حول القالب ياتباع الخطوط المتقطعة ثم مرر شريط في القوالب وتصبح زينتك جاهزة للتعليق

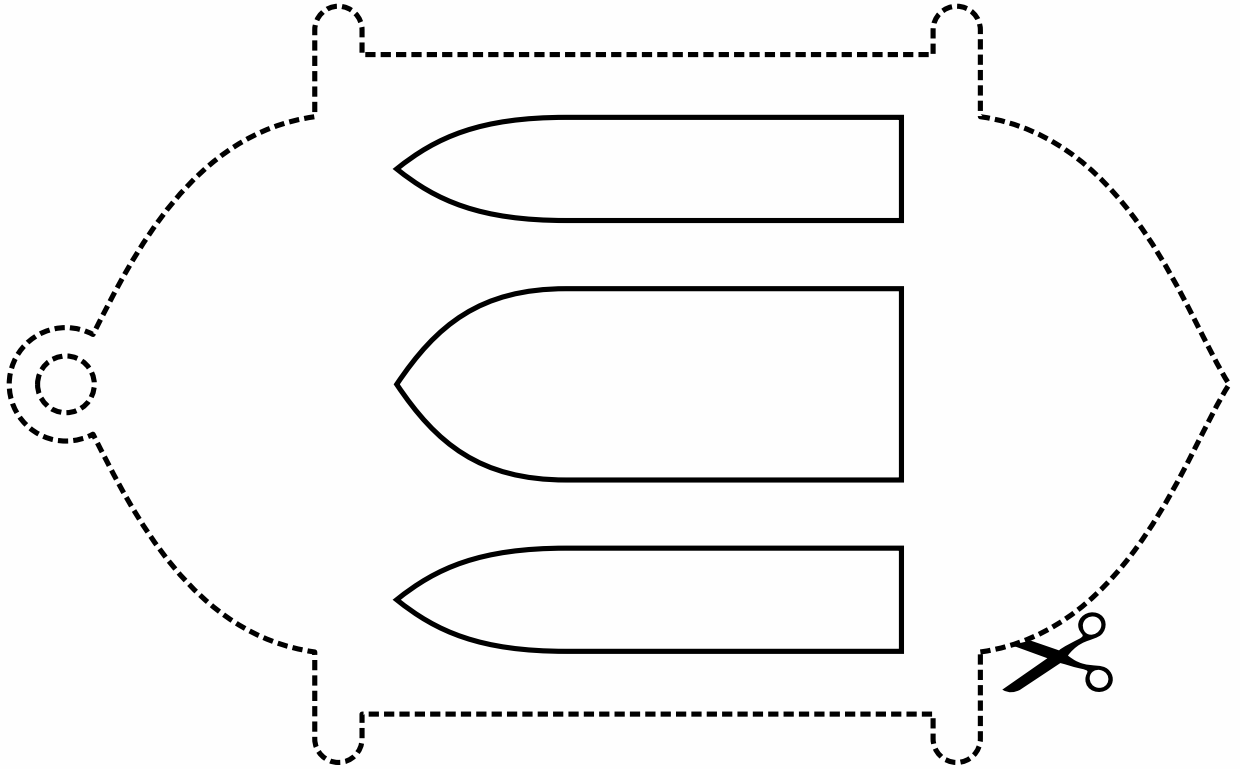
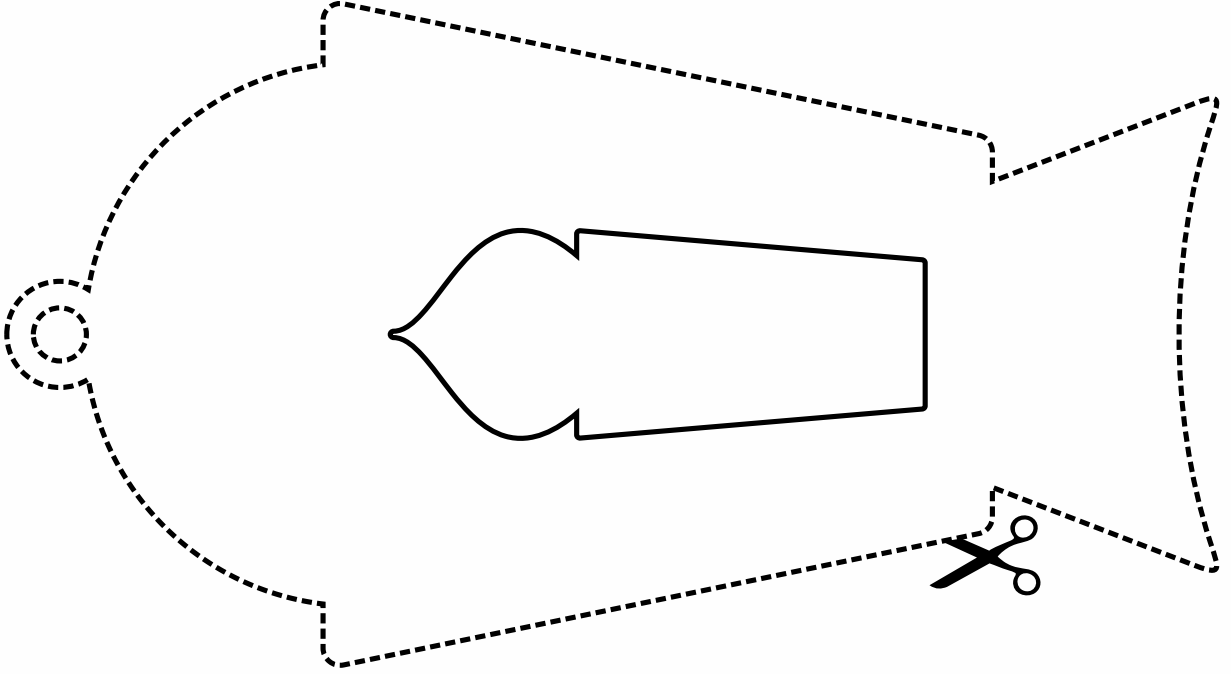

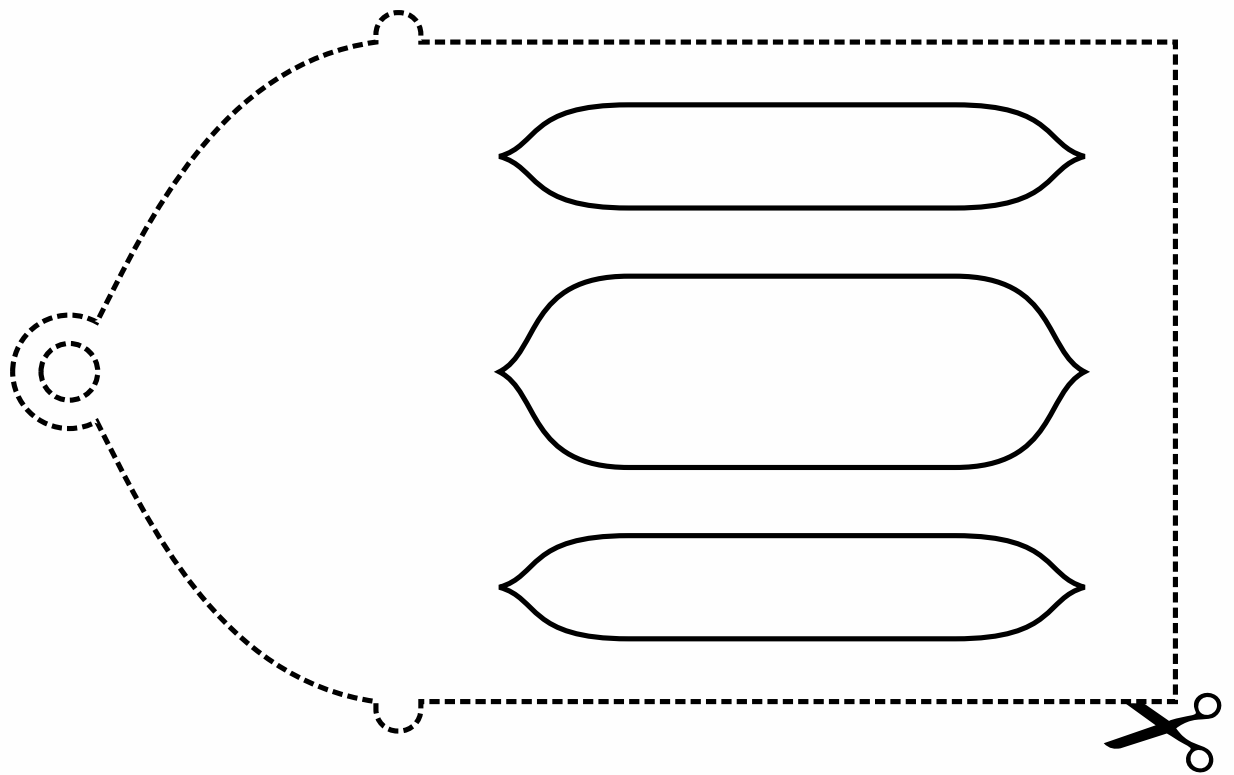
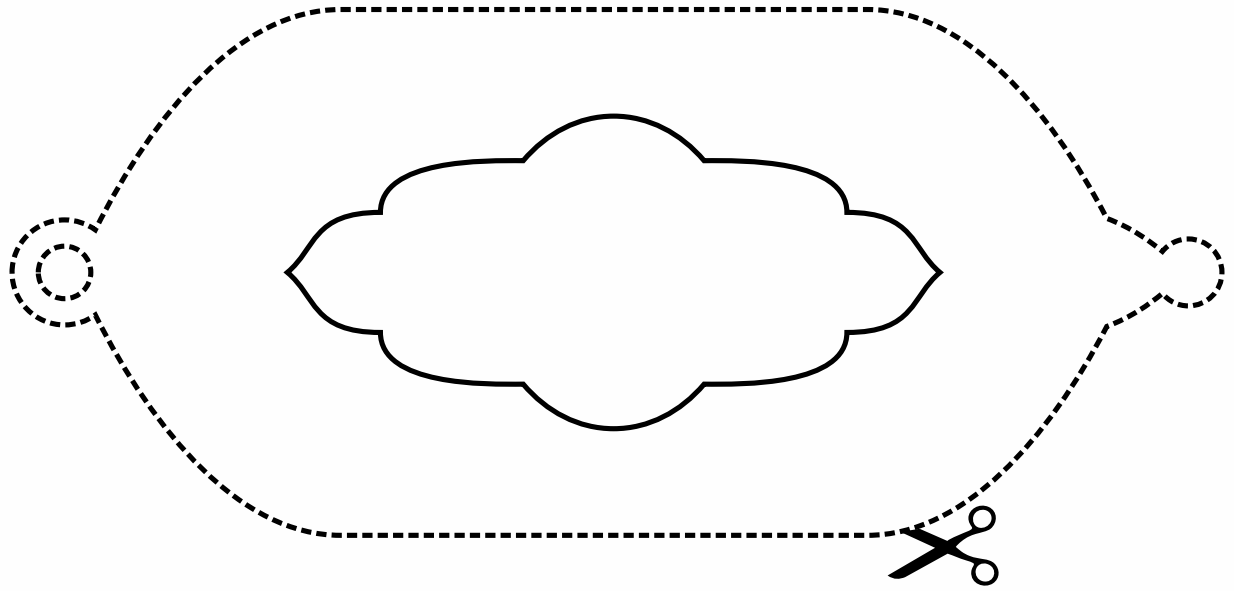

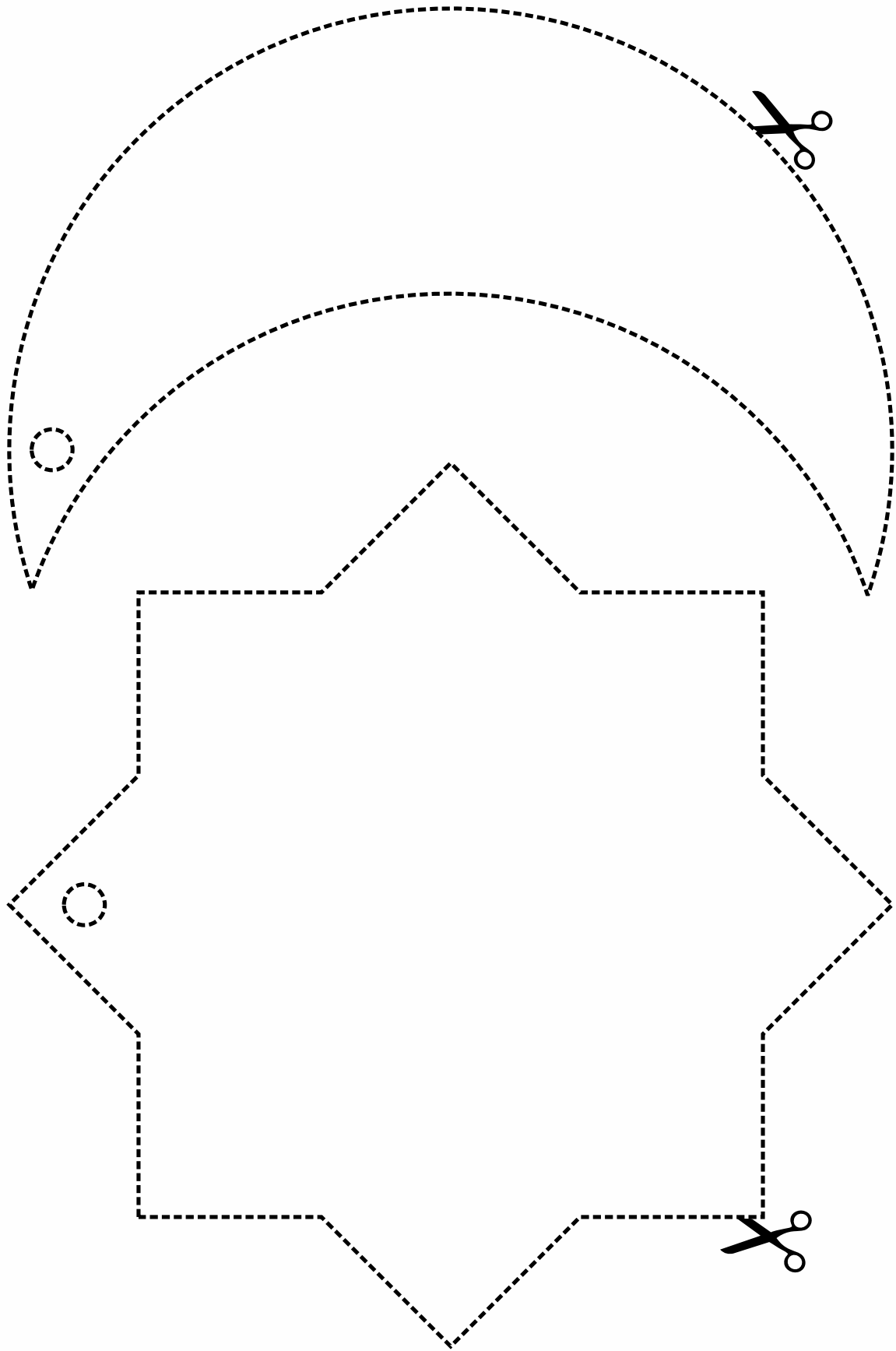

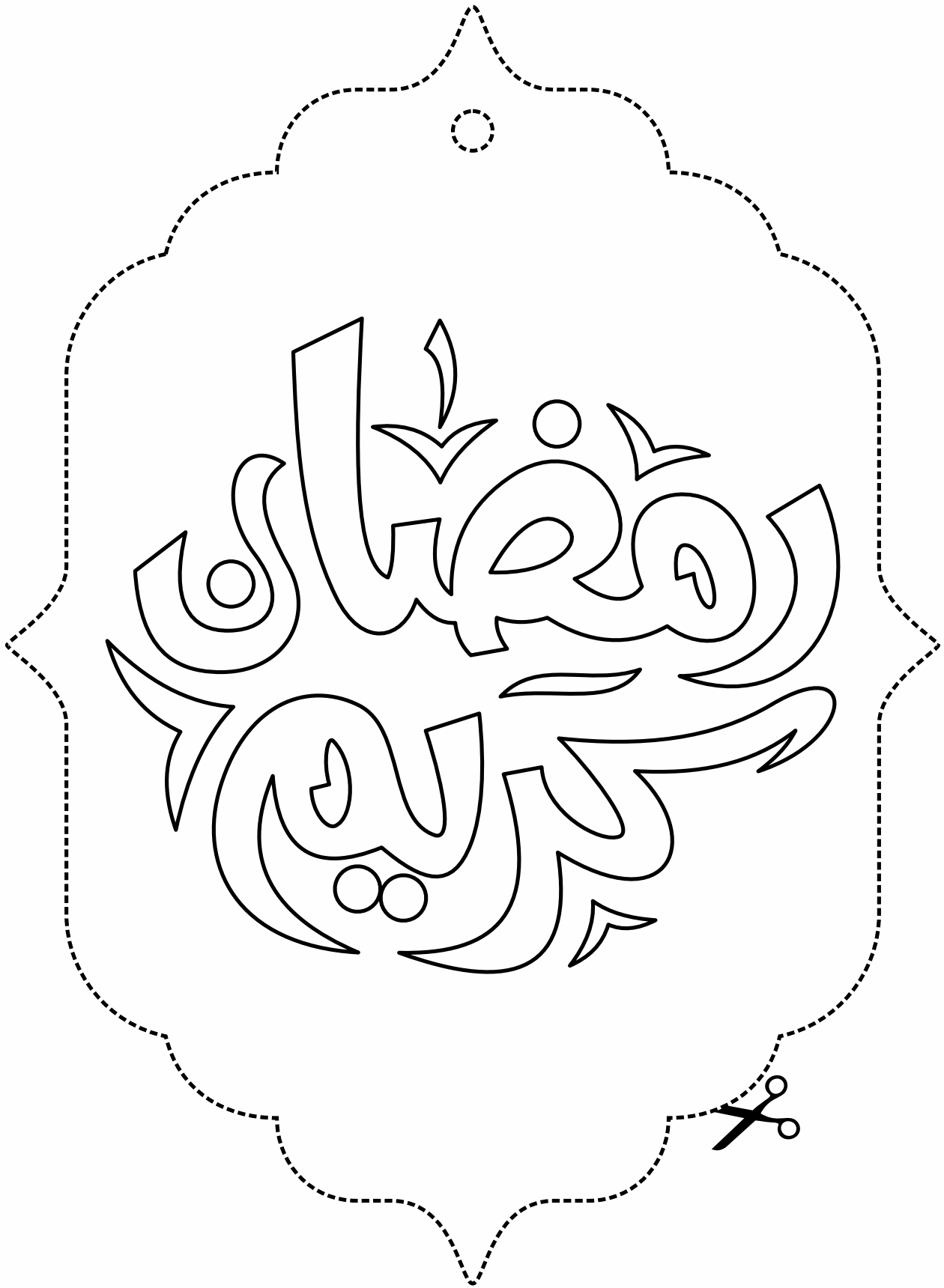



© 2023 KORKORTOON All Rights Reserved
www.korkortoon.com

KORKOR TOON
Kids Learning Books

كتاب أنشطة
رمضان