

KORKOR TOON
Kids Learning Books

Ramadan

Activities Book

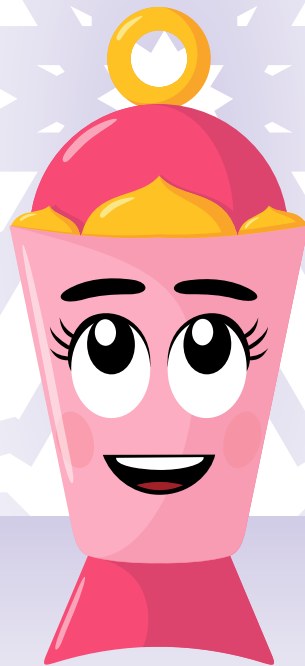

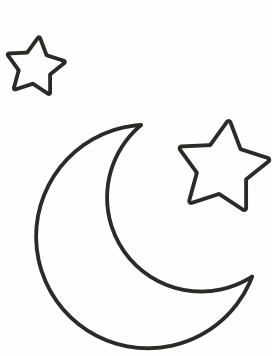

Ramadan

Activities Book

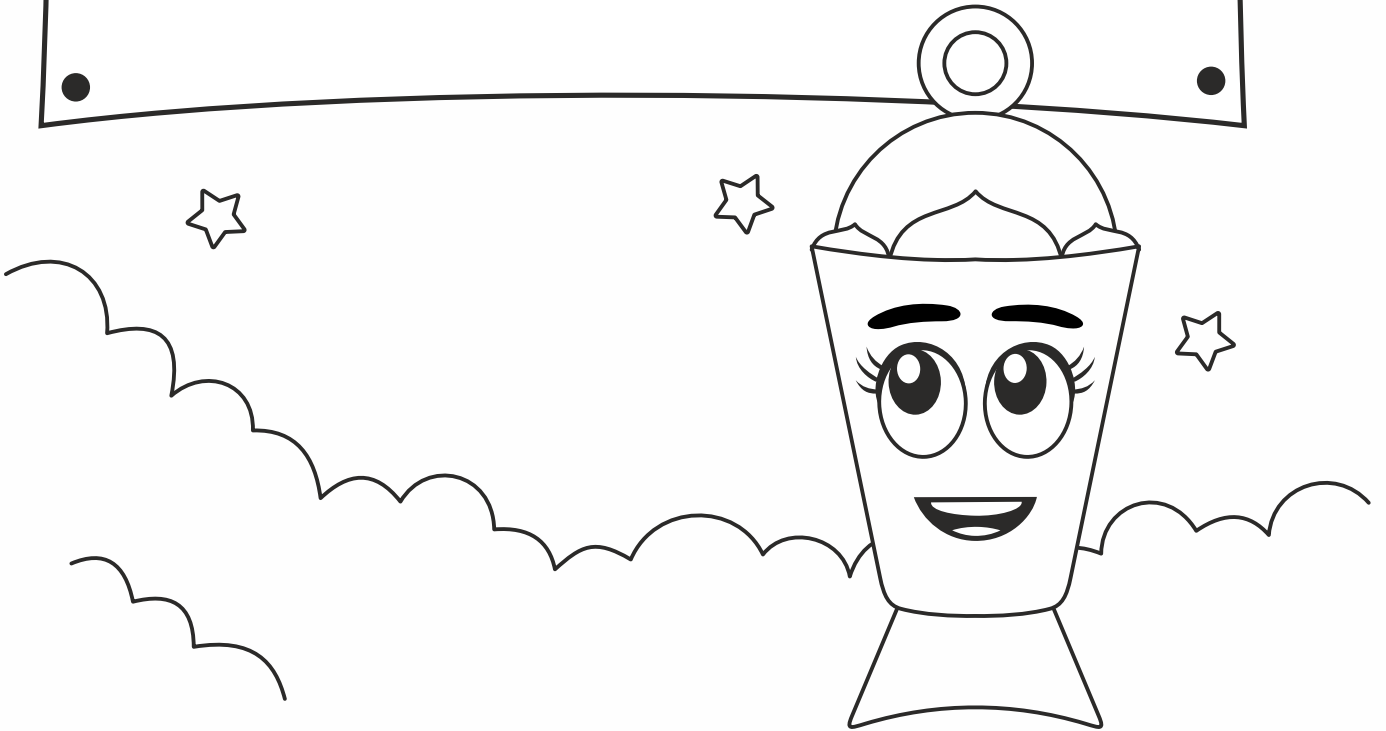
A large rectangular area with a solid border, containing three horizontal dashed lines for writing. It has four small black circles at the corners, suggesting it's a page from a book.

Ramadan

Tracker

Day	Praying	Fasting	Quran	Doaa	Charity
1					
2					
3					
4					
5					
6					
7					
8					
9					
10					
11					
12					
13					
14					
15					

Ramadan

Tracker

Day	Praying	Fasting	Quran	Doaa	Charity
16					
17					
18					
19					
20					
21					
22					
23					
24					
25					
26					
27					
28					
29					
30					

Masjid Maze

Can you help the boy to get to Masjid in time for Taraweeh?

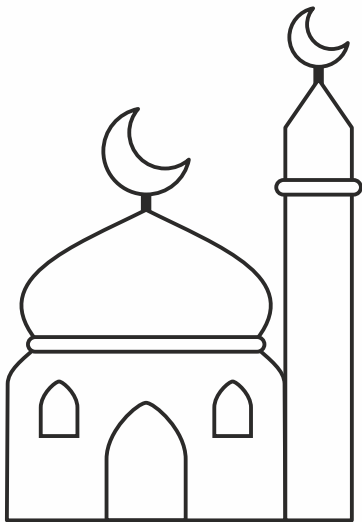
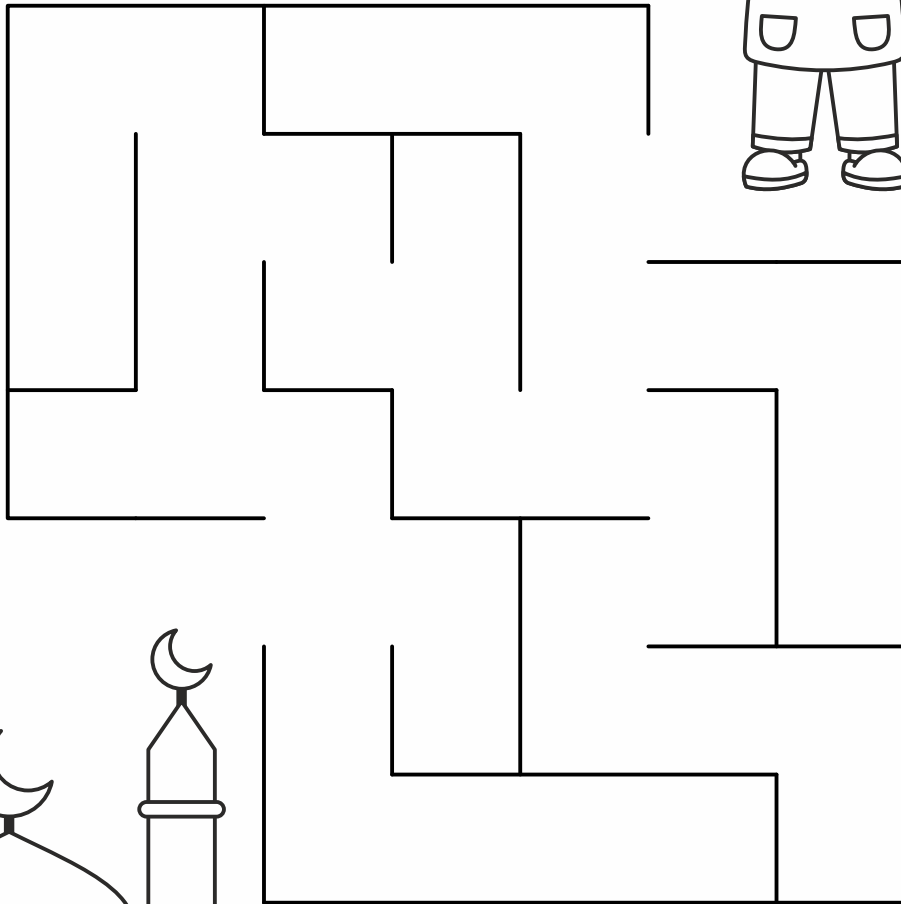

Which one is different

Circle picture that is different in each row

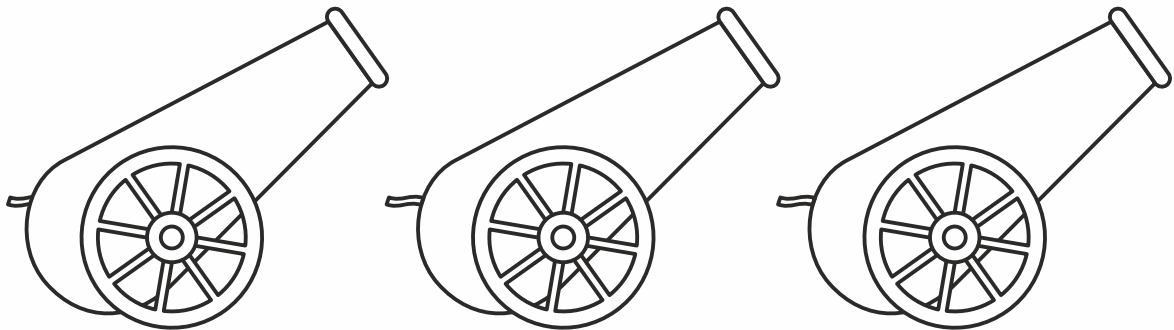
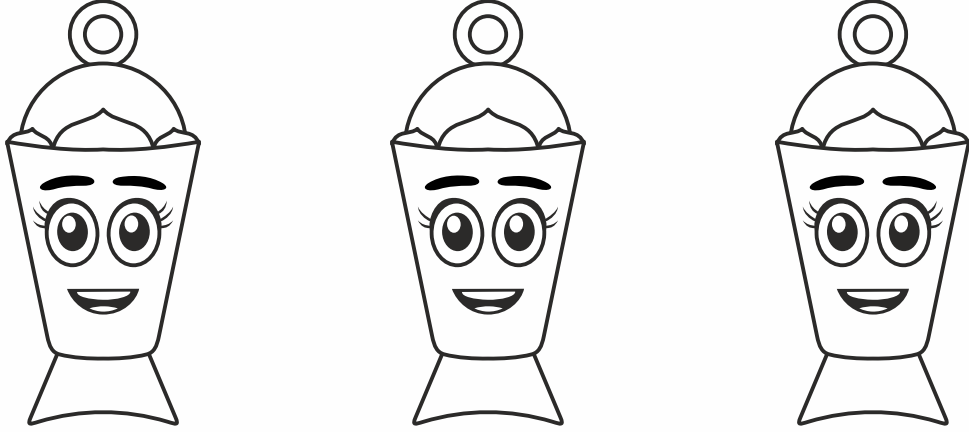

Which is different

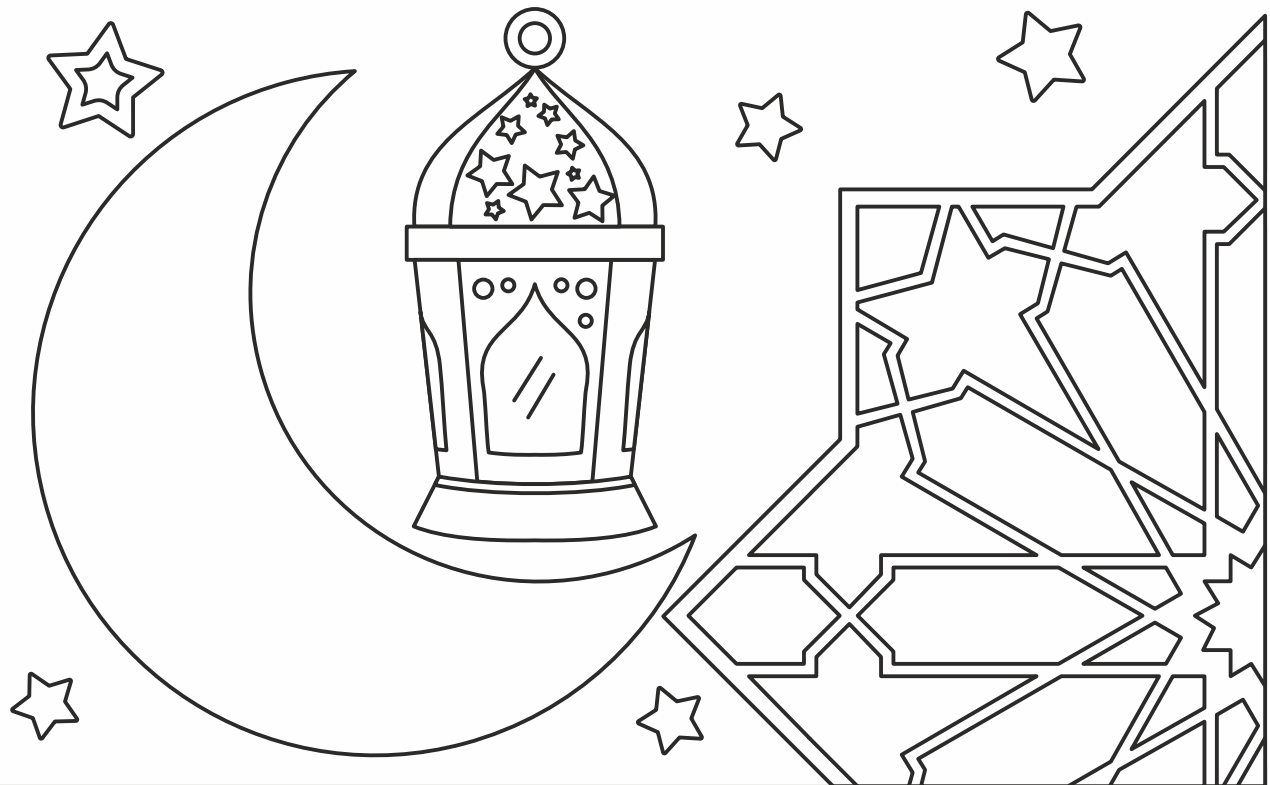
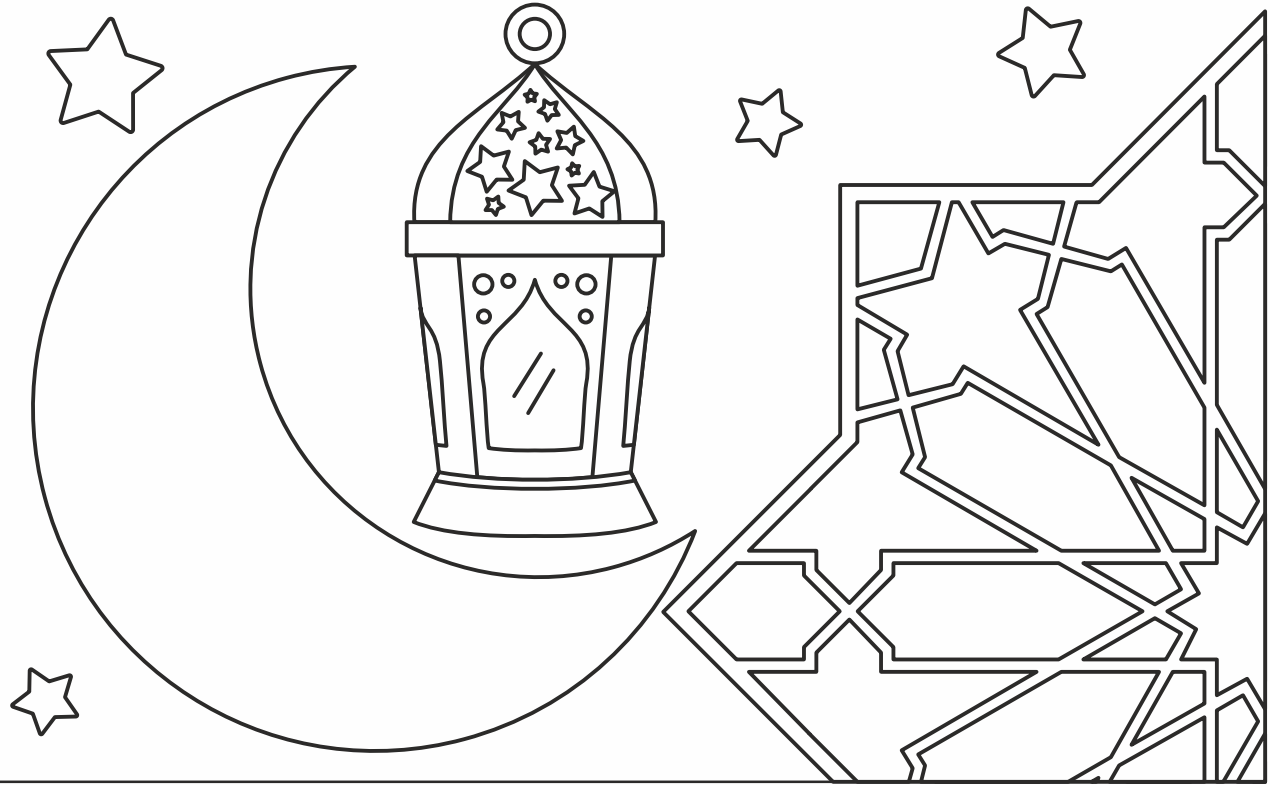

Circle the 5 differences between these two pictures

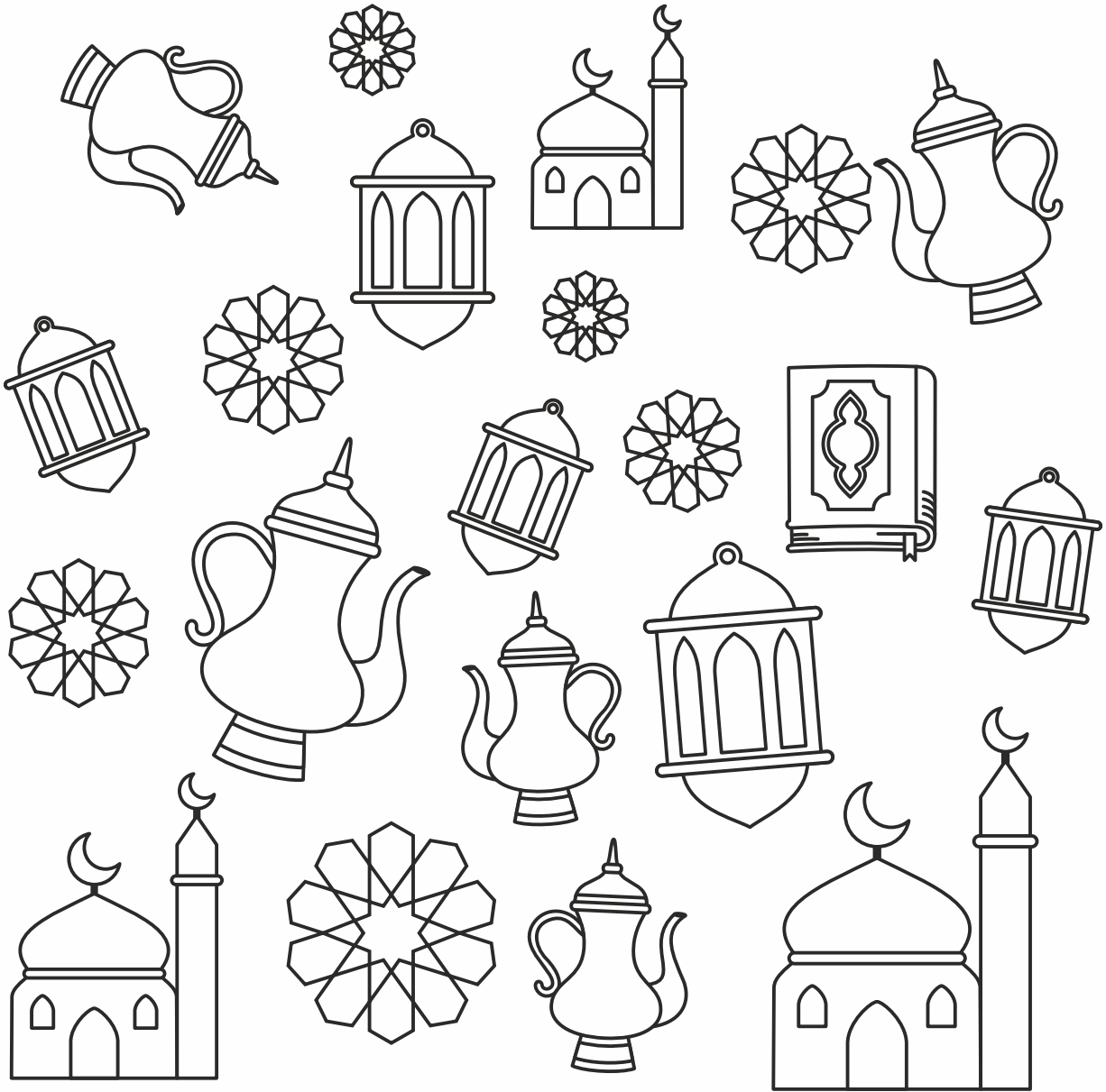

Count & Color

Count and write the number of each picture and color them

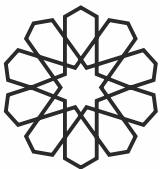
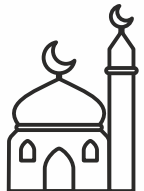

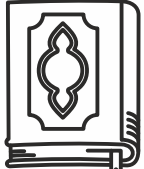
				
--	--	--	---	--

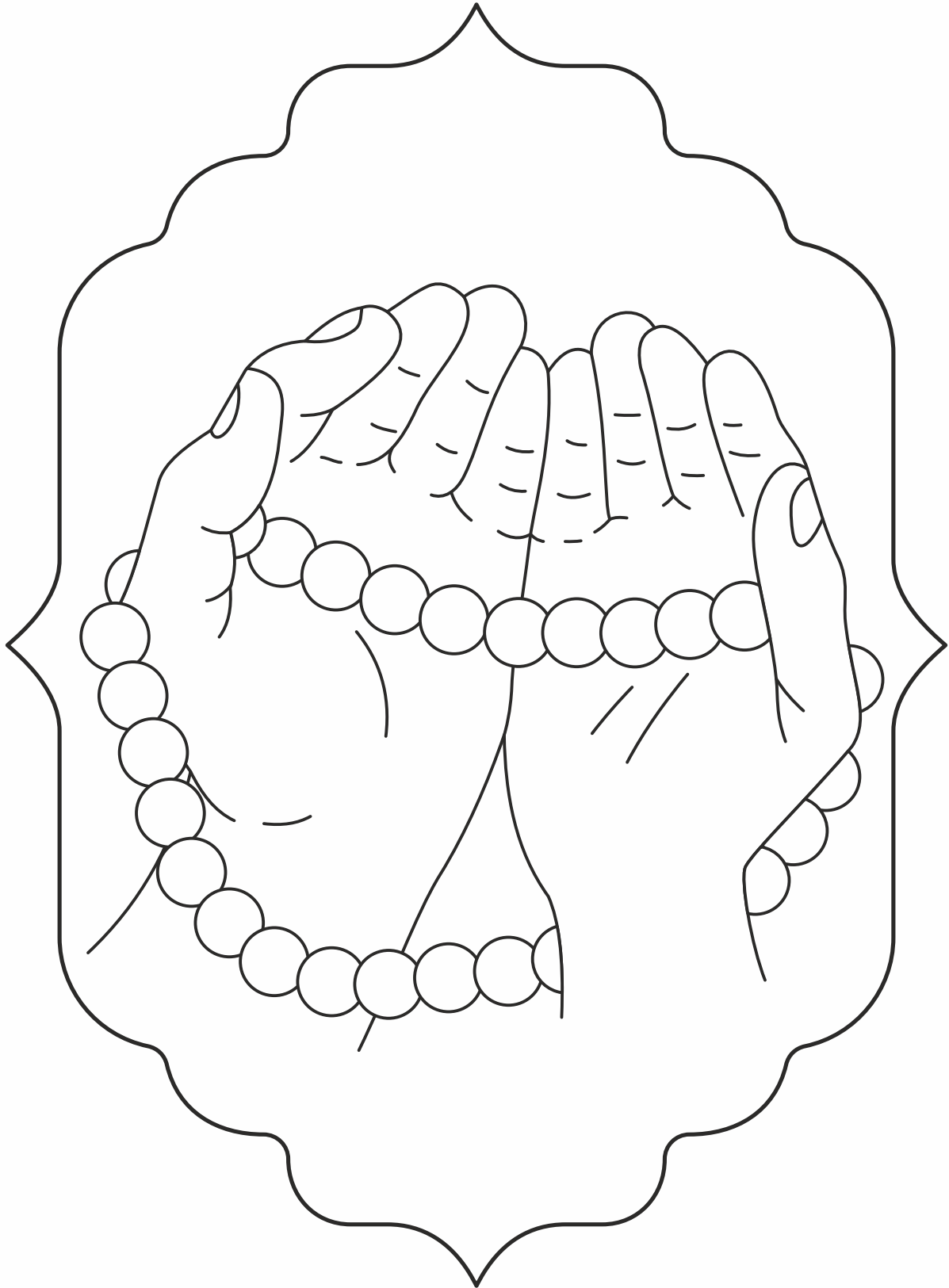

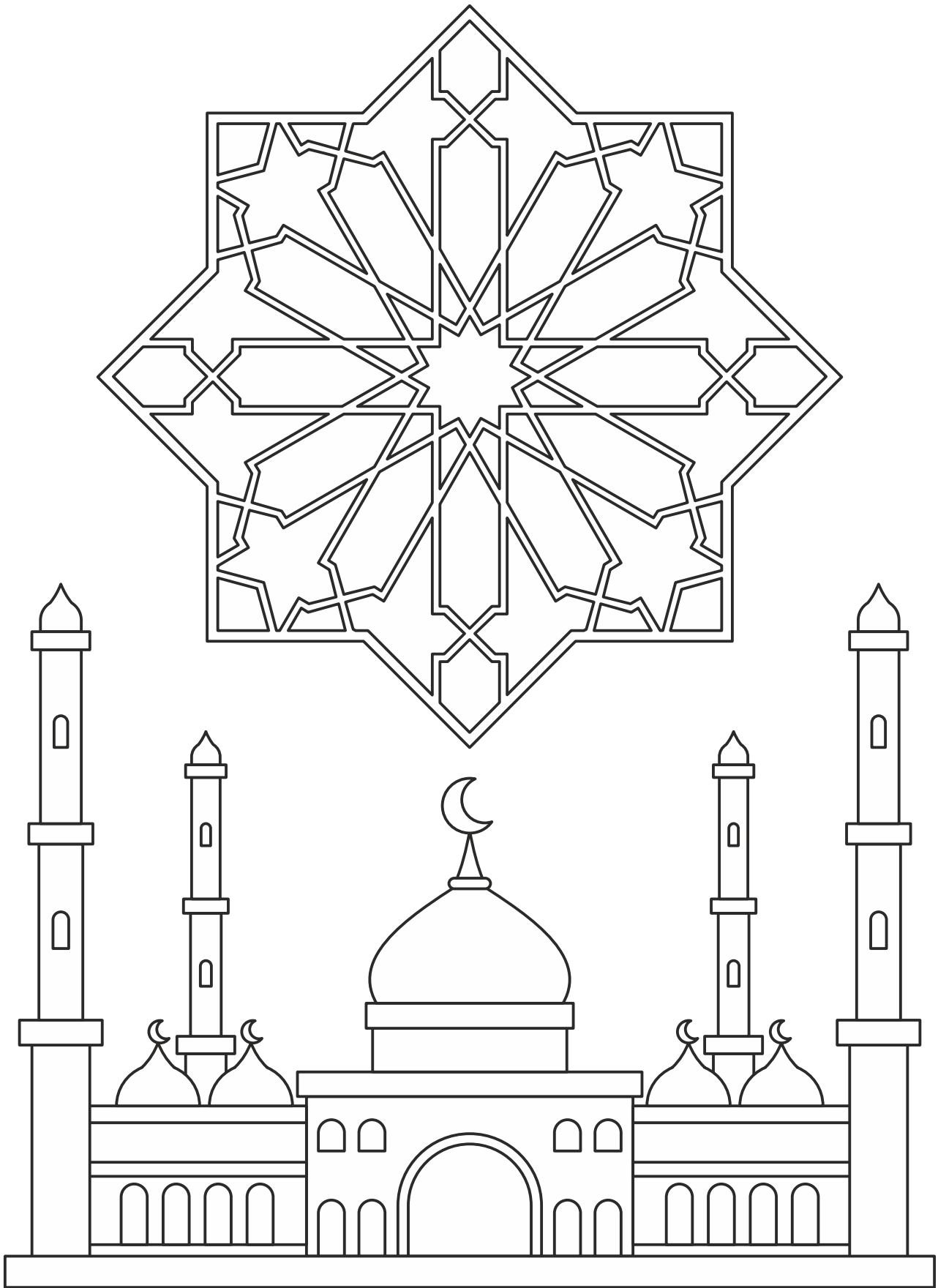

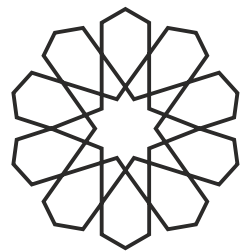
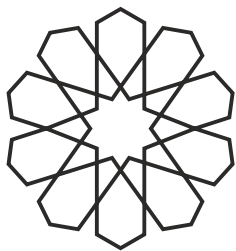
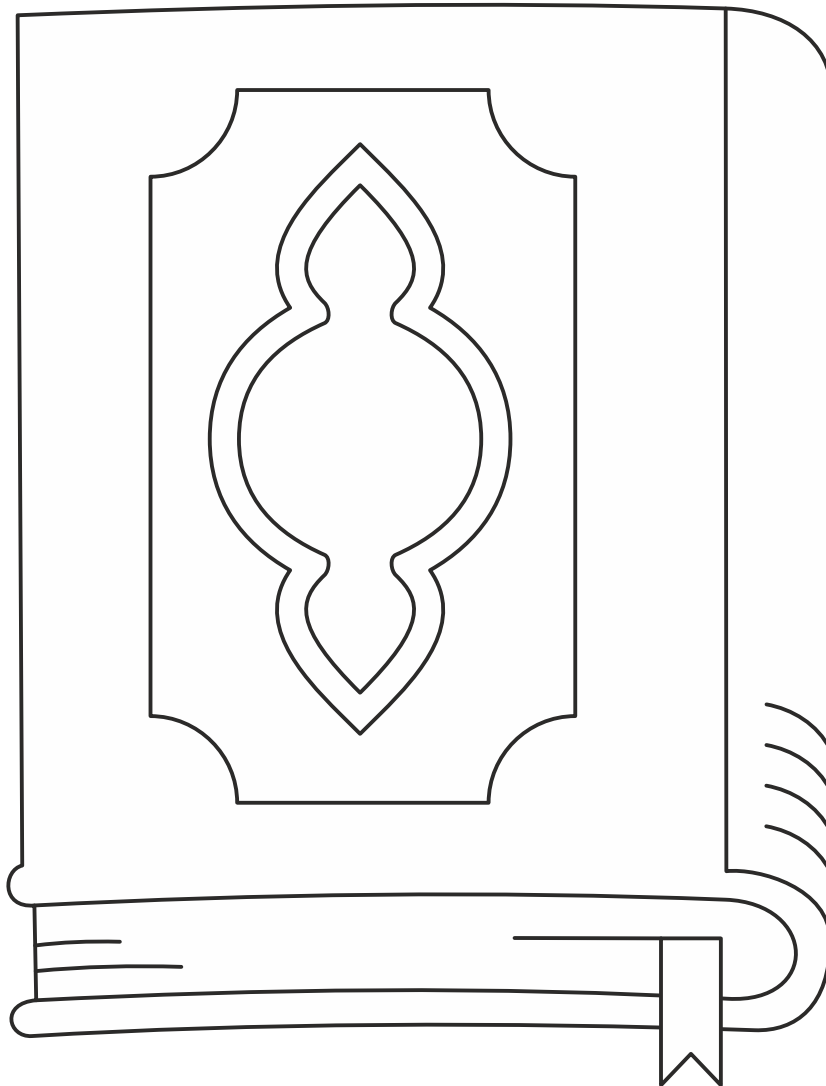
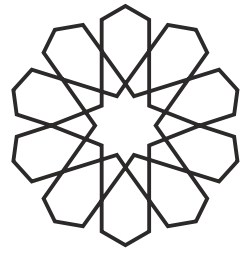
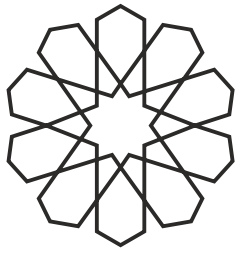

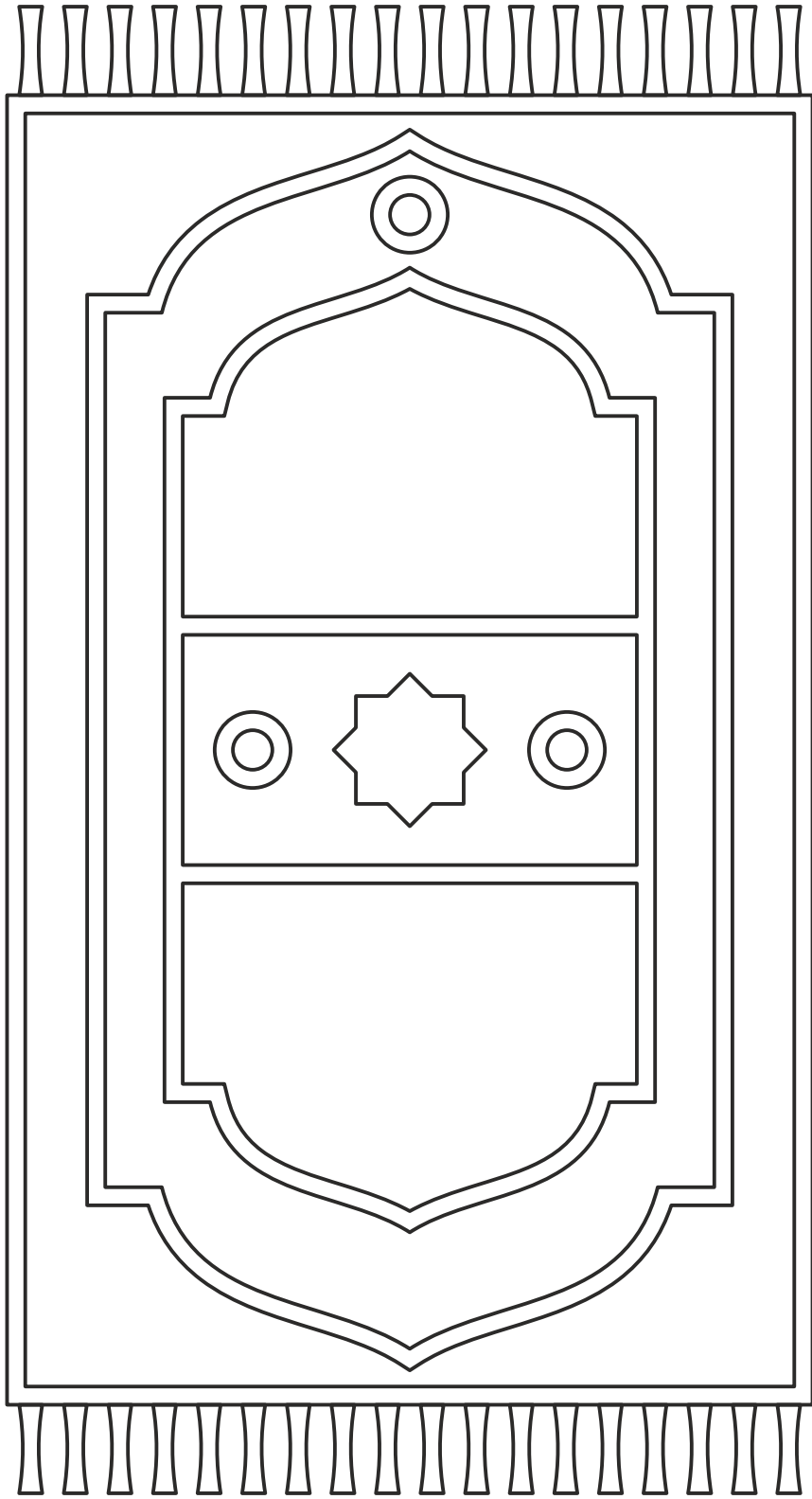

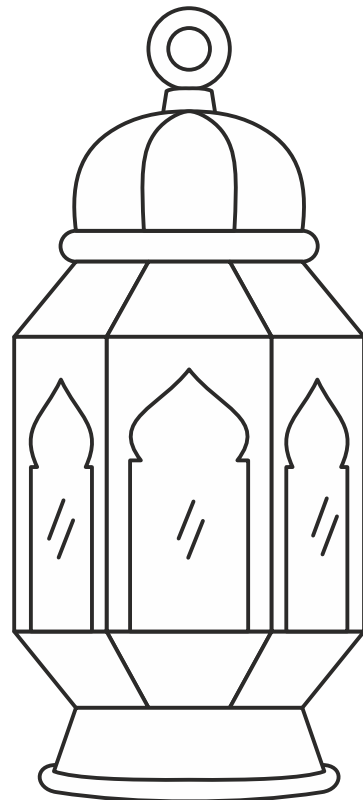
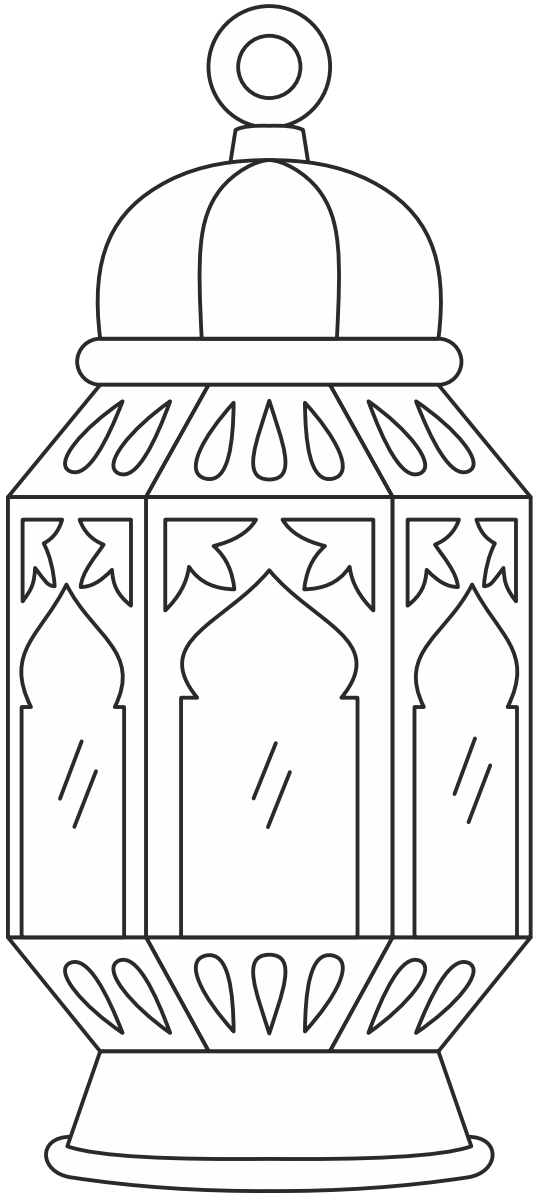
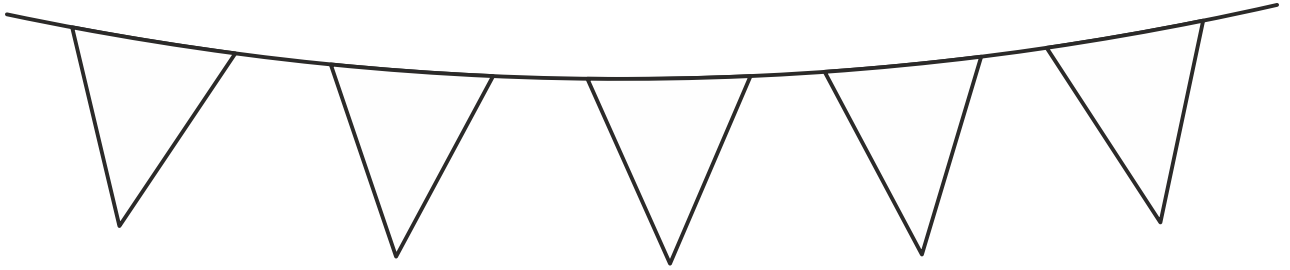

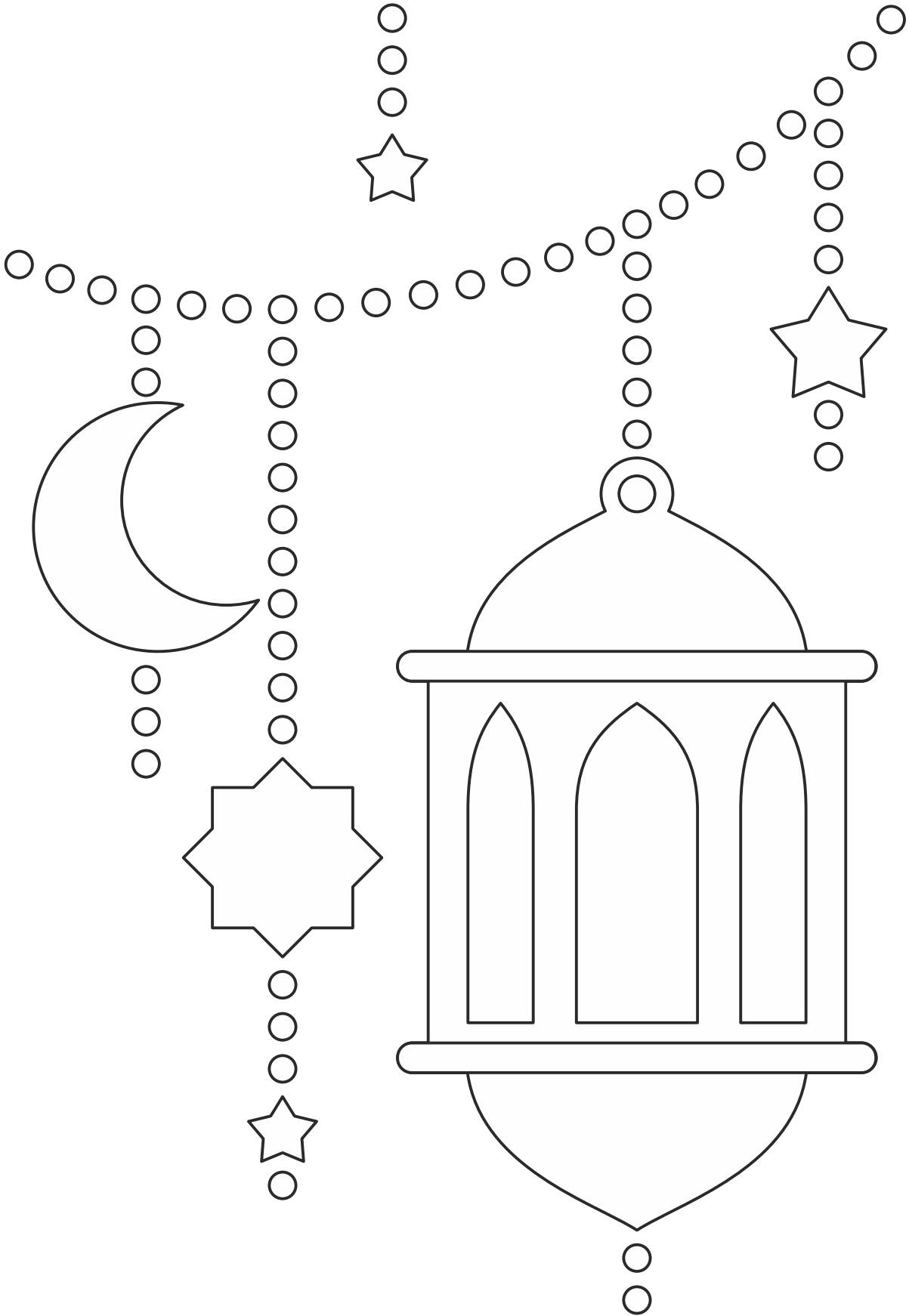

Kamaidan Kareem

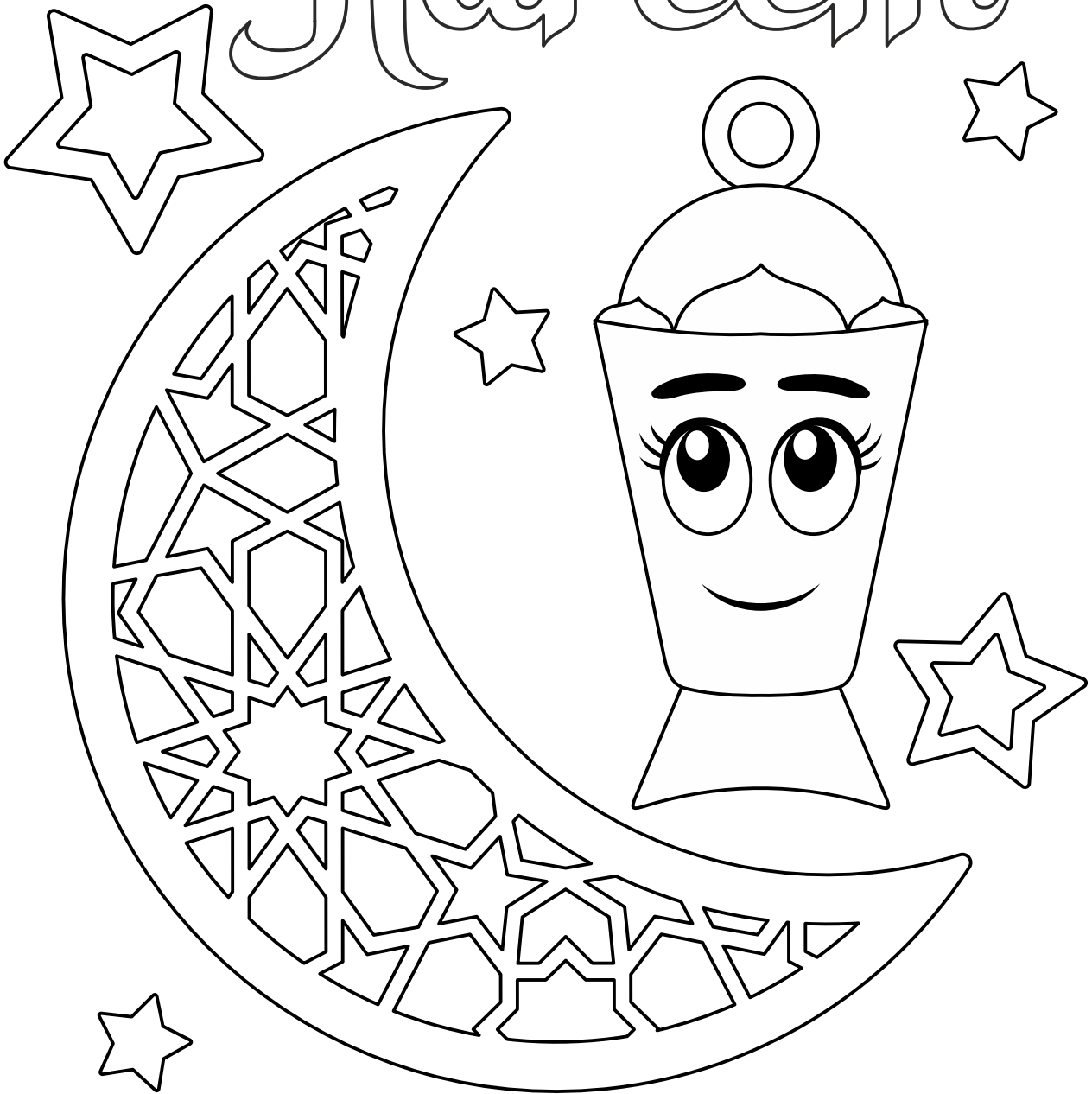

Eftar Maze

Connect the jug to the dates plate through the maze to prepare Eftar

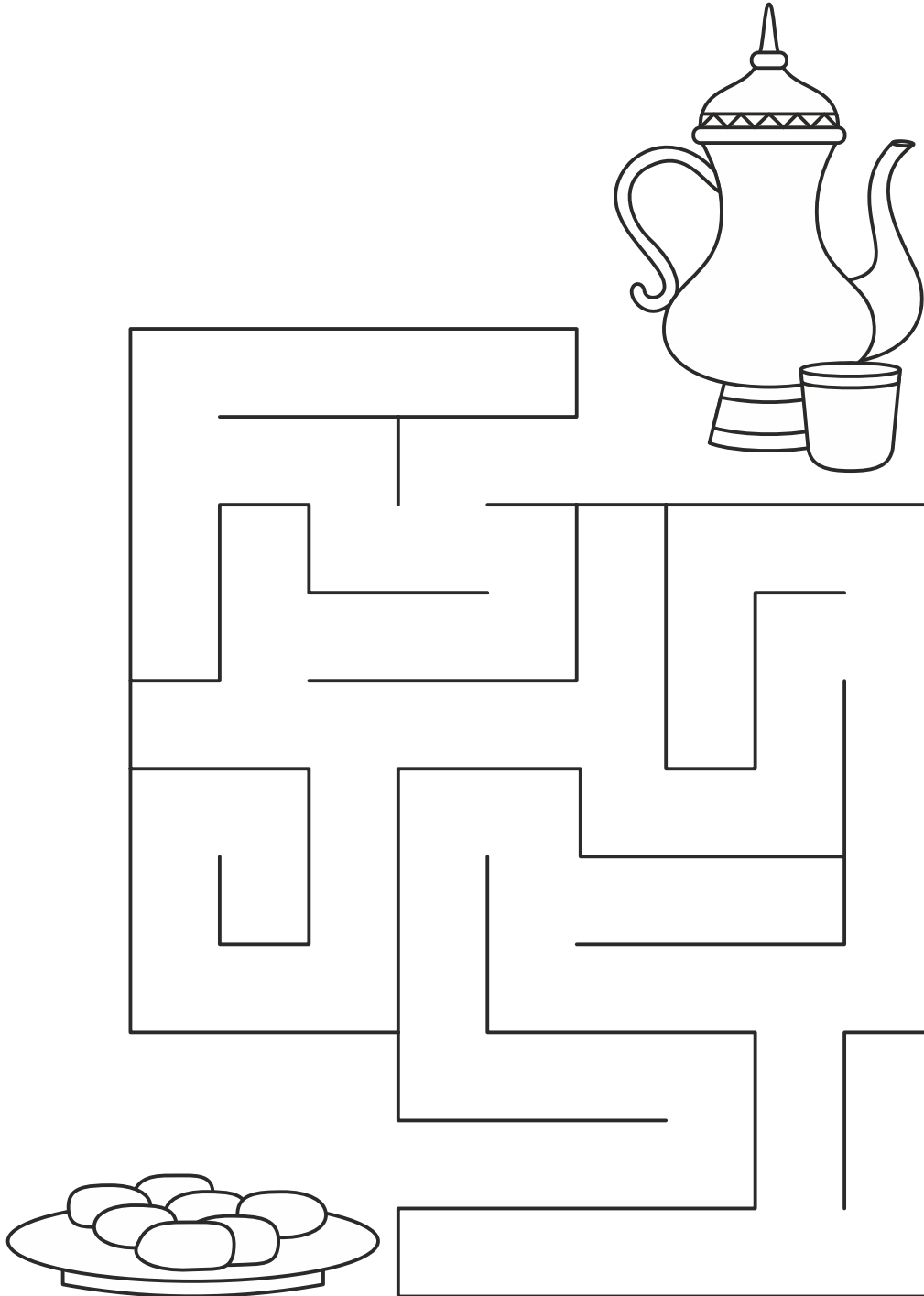

Lantern Maze

Help the candle to find the way to the lantern through the maze

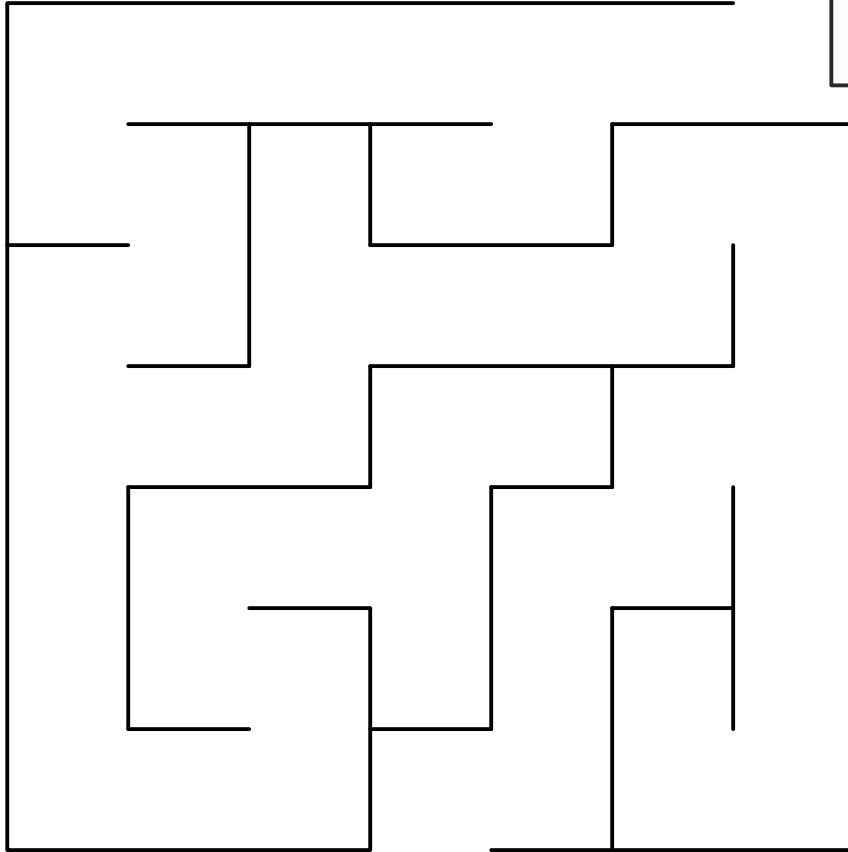

Which one is different

Circle picture that is different in each row

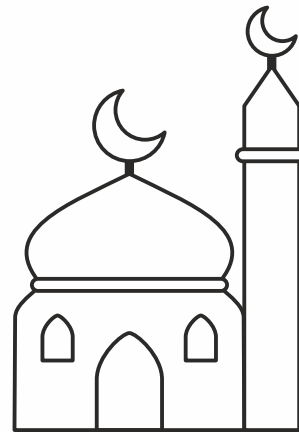
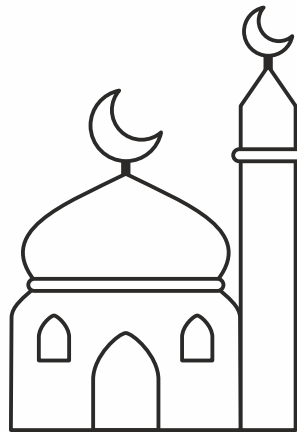
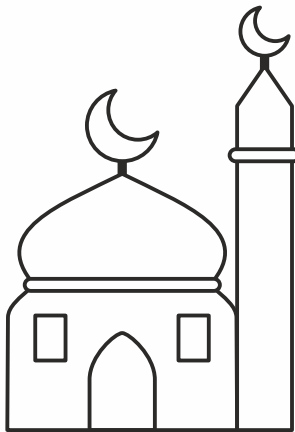
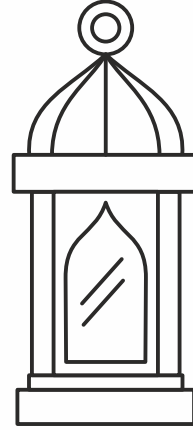
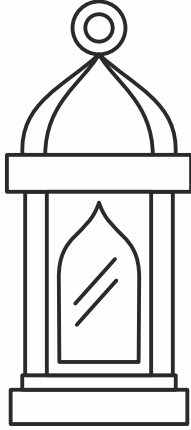
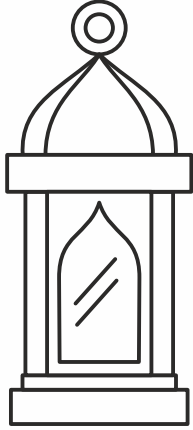

Which is different

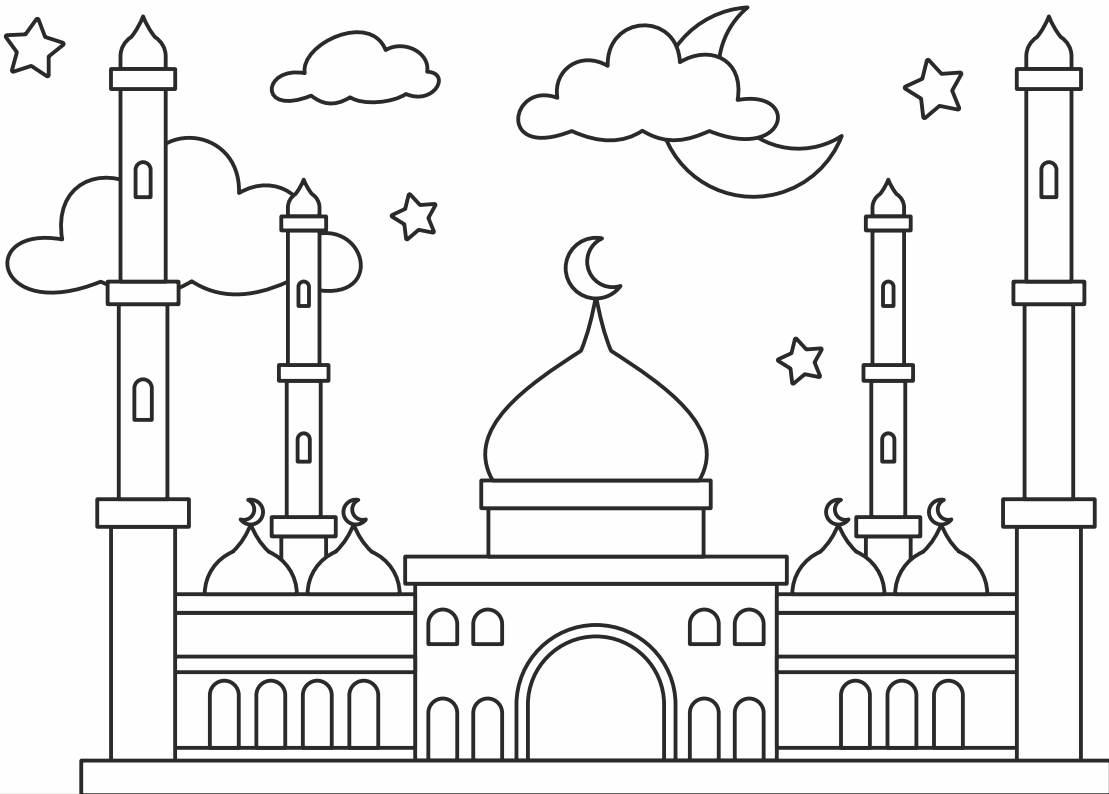
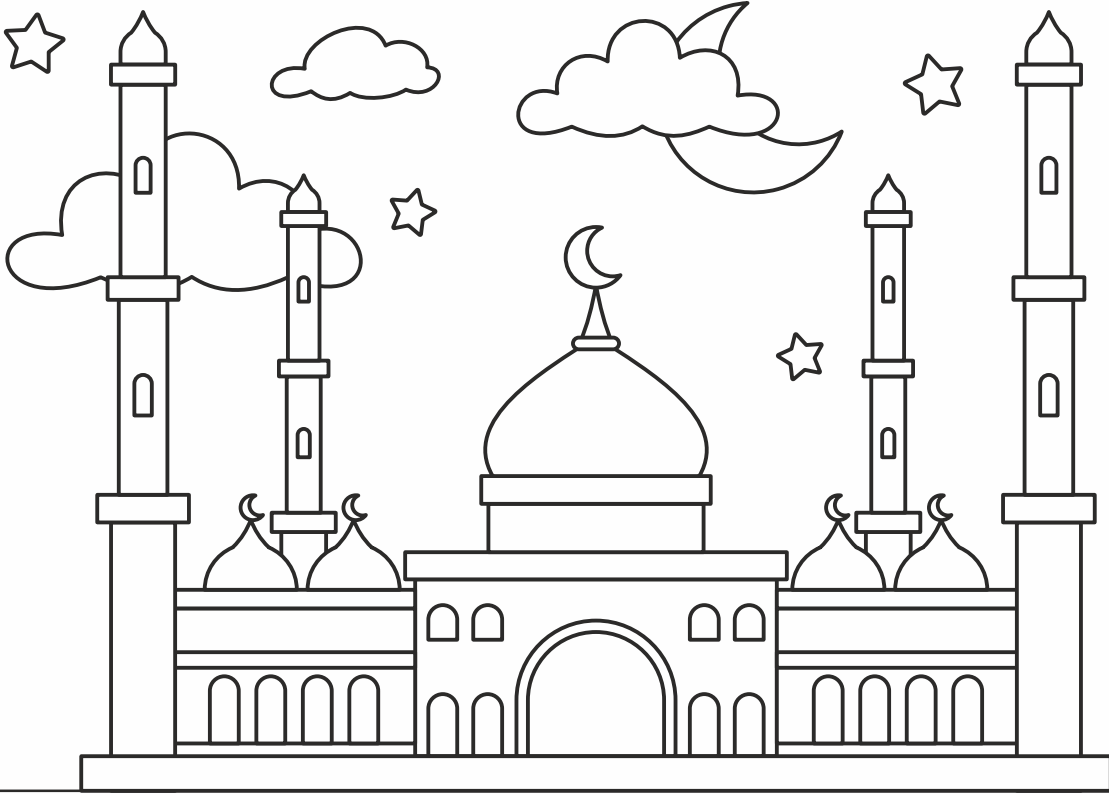

Circle the 5 differences between these two pictures



Count & Color

Count and write the number of each picture and color them

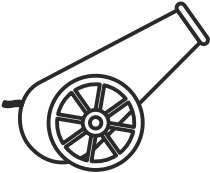

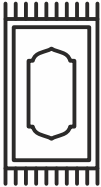
				
--	--	--	---	--

Word search

Circle the words in the puzzle below

P	R	A	Y	I	N	G	S	B
L	N	R	E	T	N	A	L	G
M	I	E	F	T	A	R	U	Y
N	A	R	U	Q	D	A	T	E
G	N	I	T	S	A	F	W	L
D	I	J	S	A	M	E	F	N
O	Q	C	H	A	A	I	T	Y
A	H	O	I	S	R	D	I	A
A	T	A	R	A	W	E	E	H

RAMADAN

EFTAR

LANTERN

DOAA

FASTING

CHARITY

EID

DATE

MASJID

PRAYING

TARAWEEH

QURAN

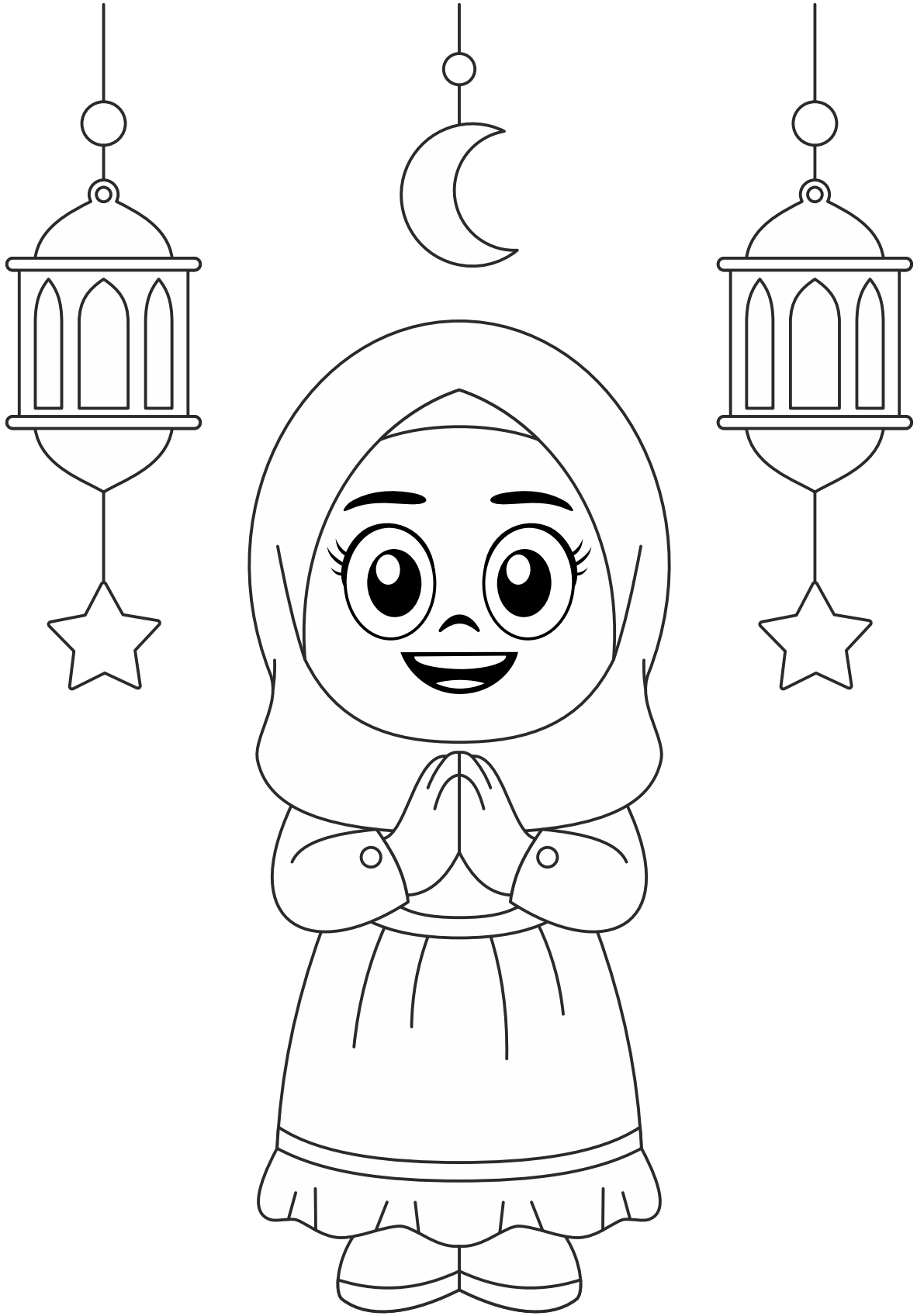

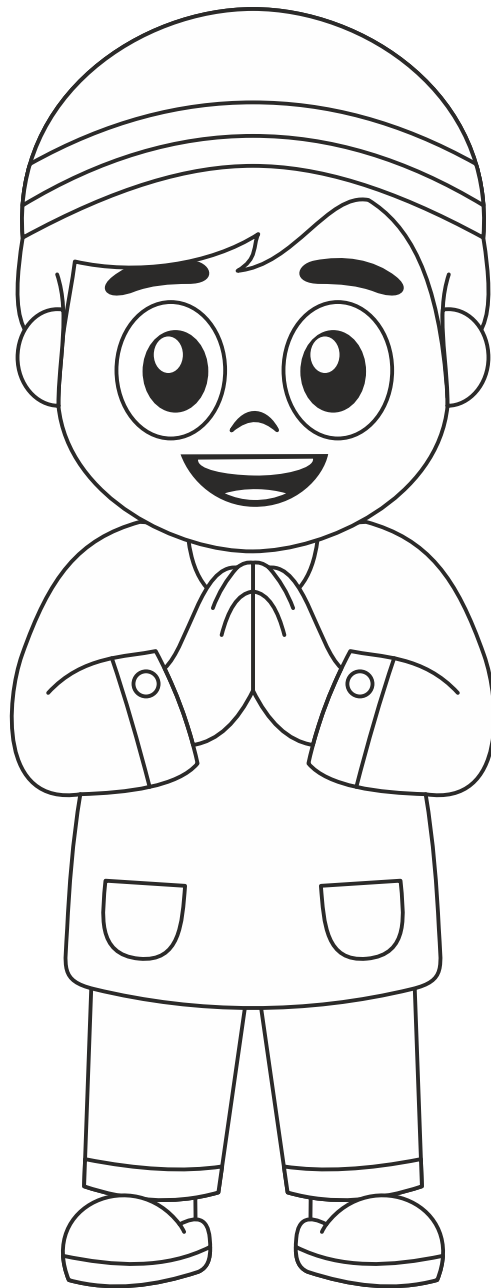
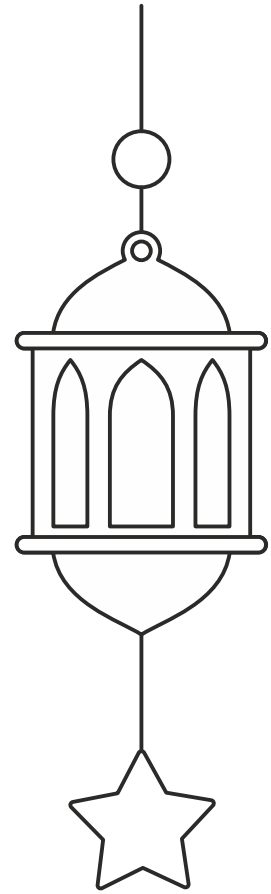
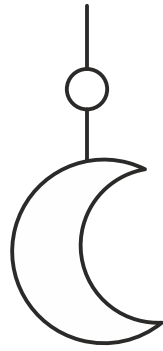
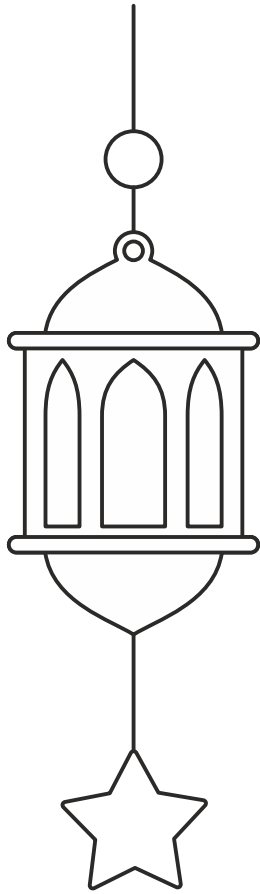

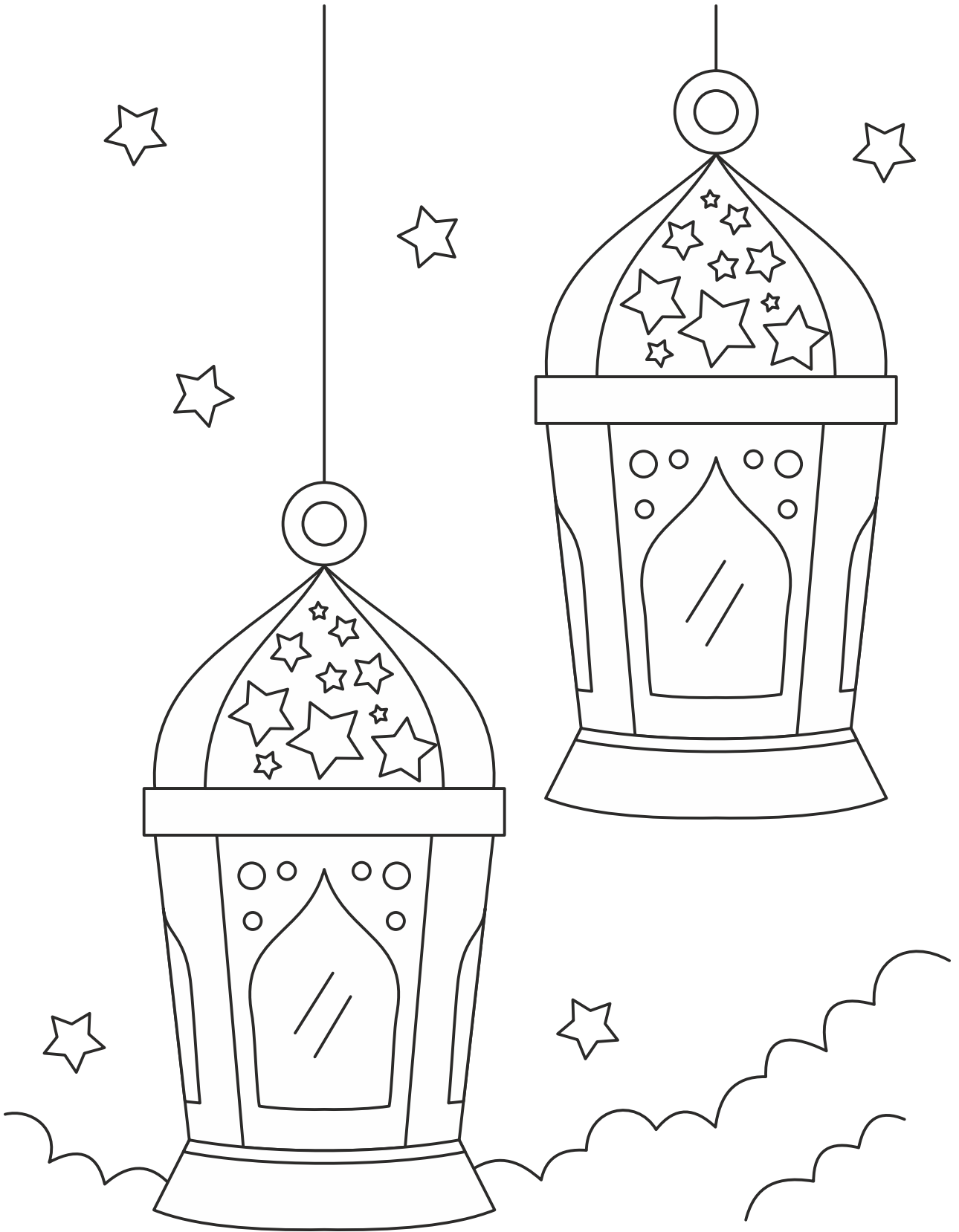



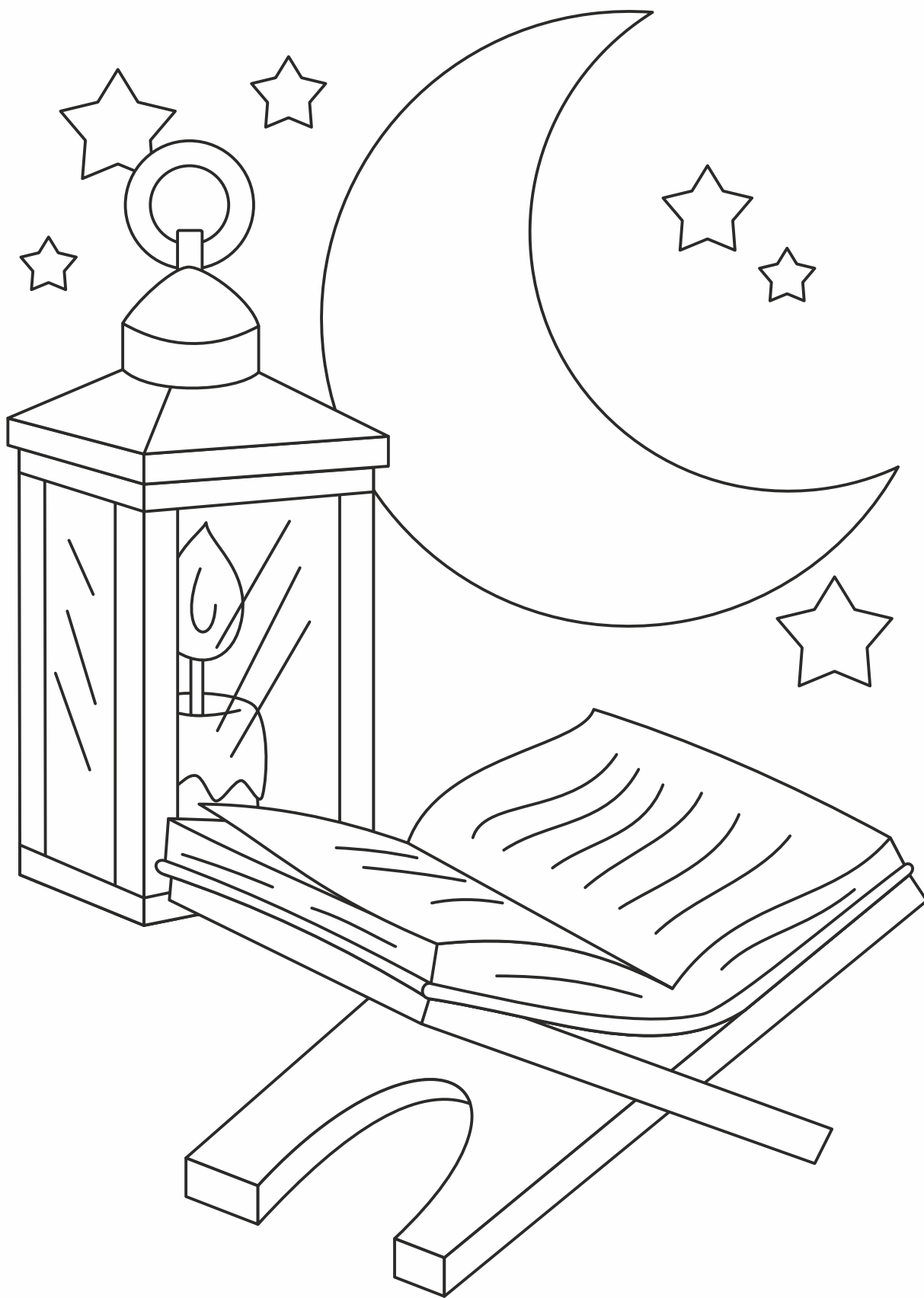

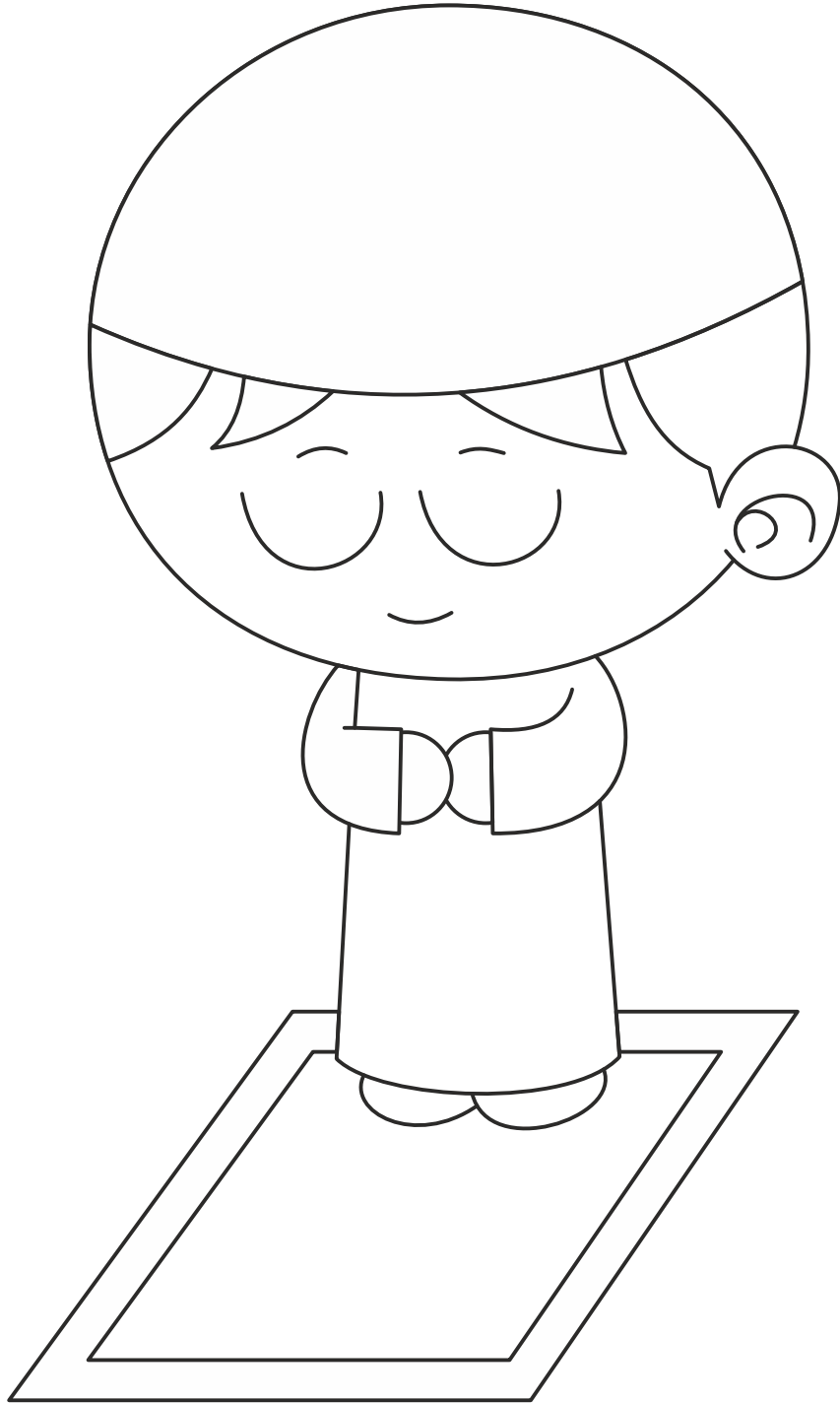

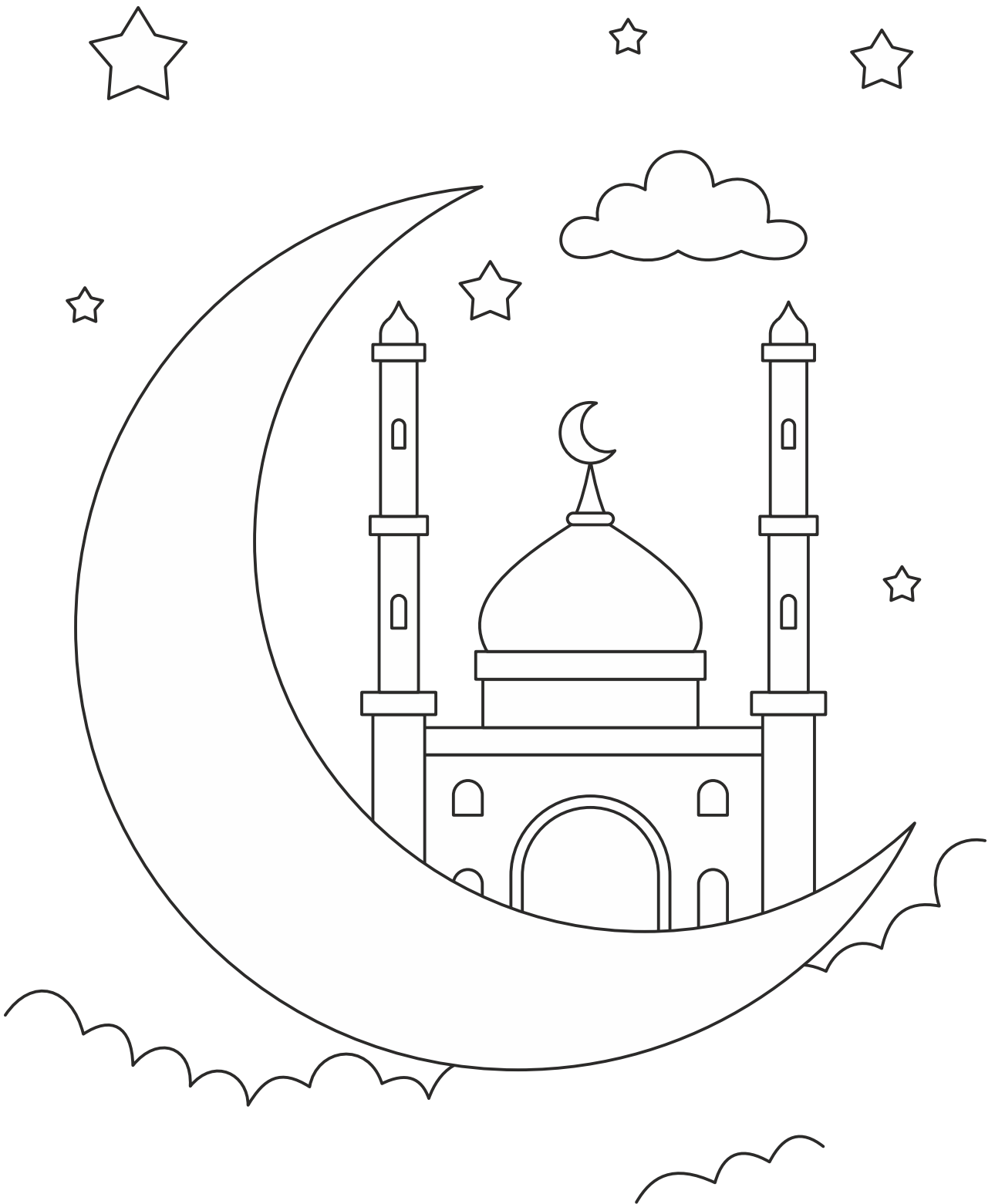

Color & Cut

Color & cut the template, following the dotted lines

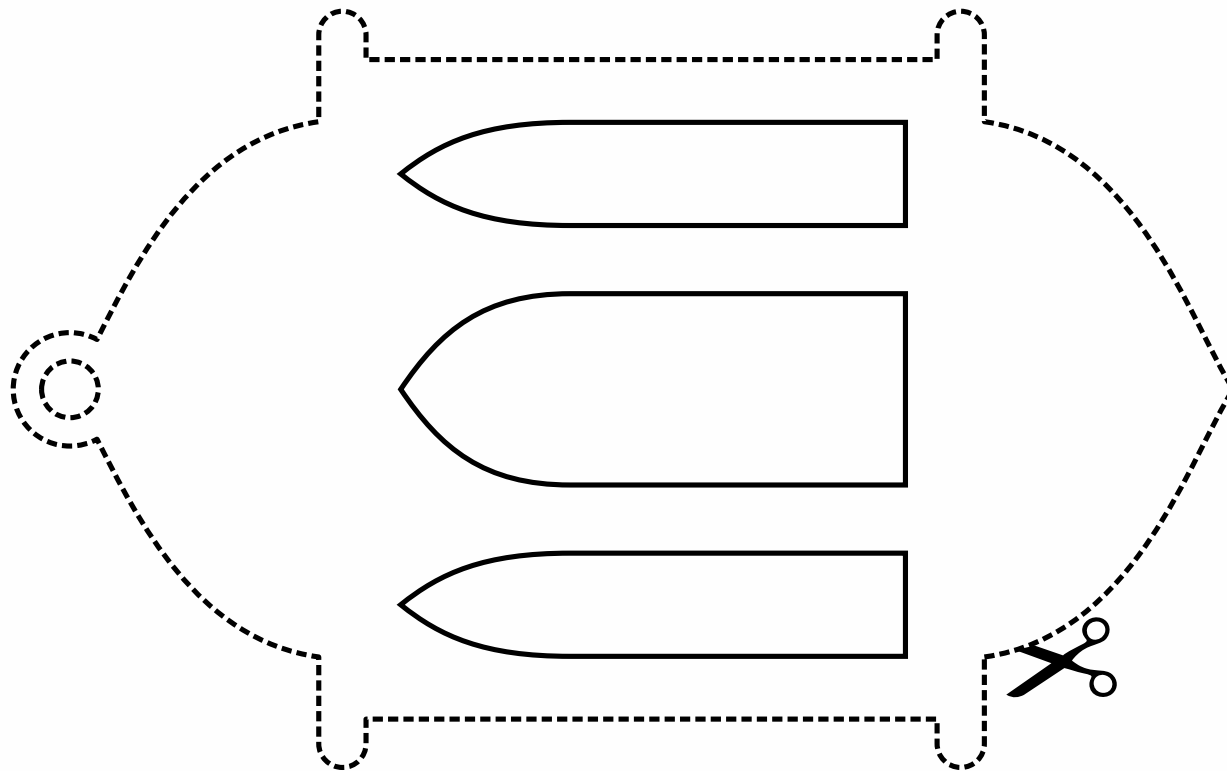
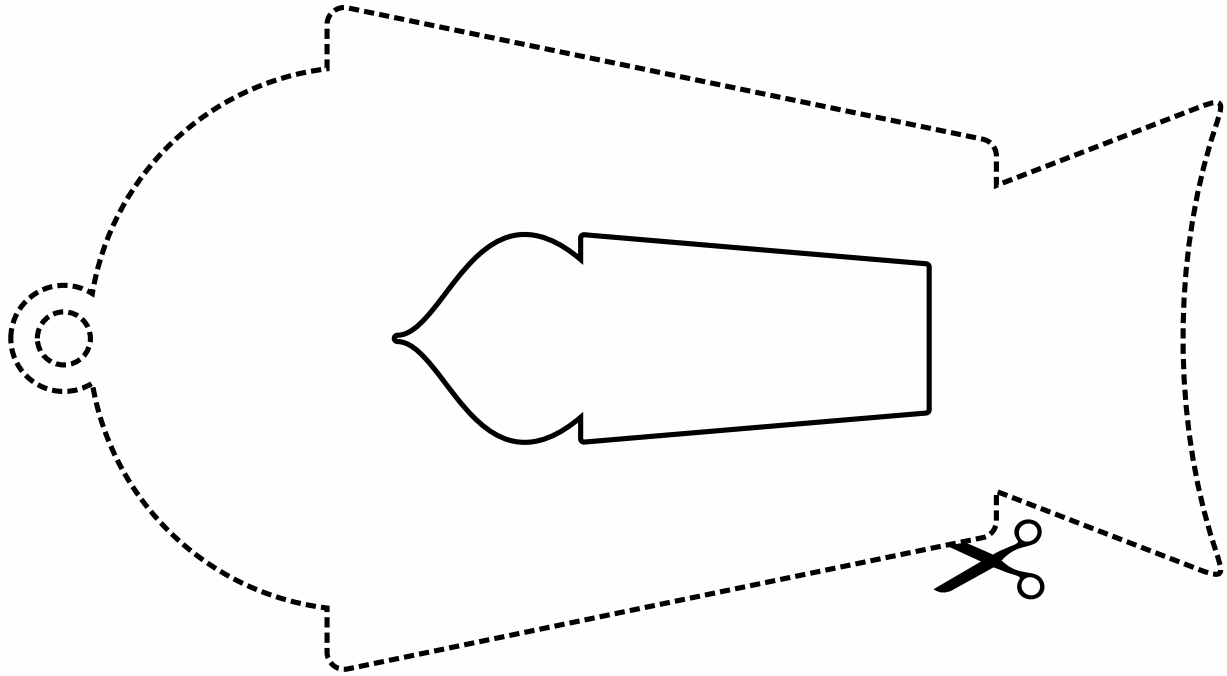

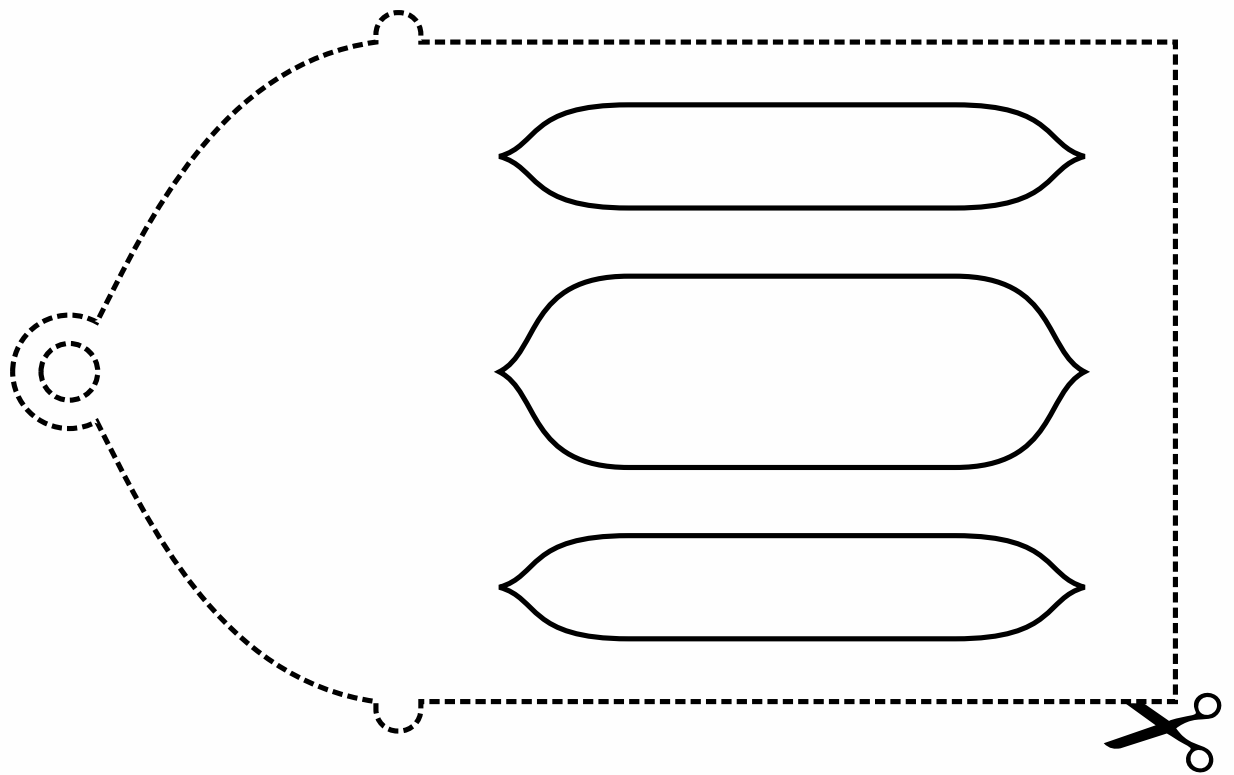
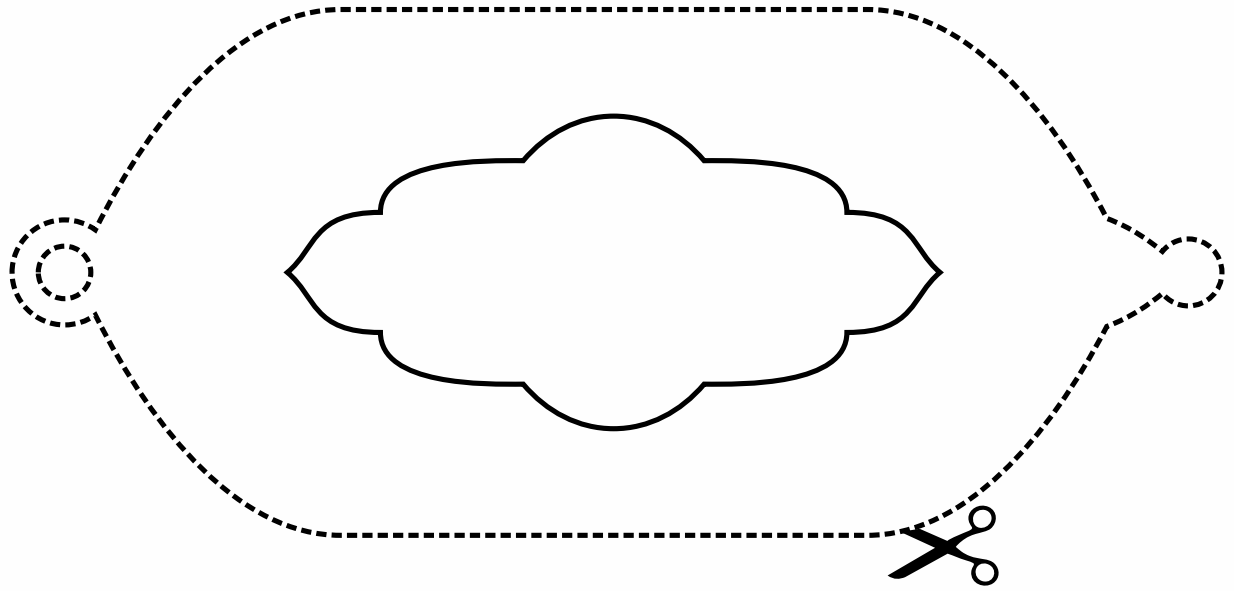

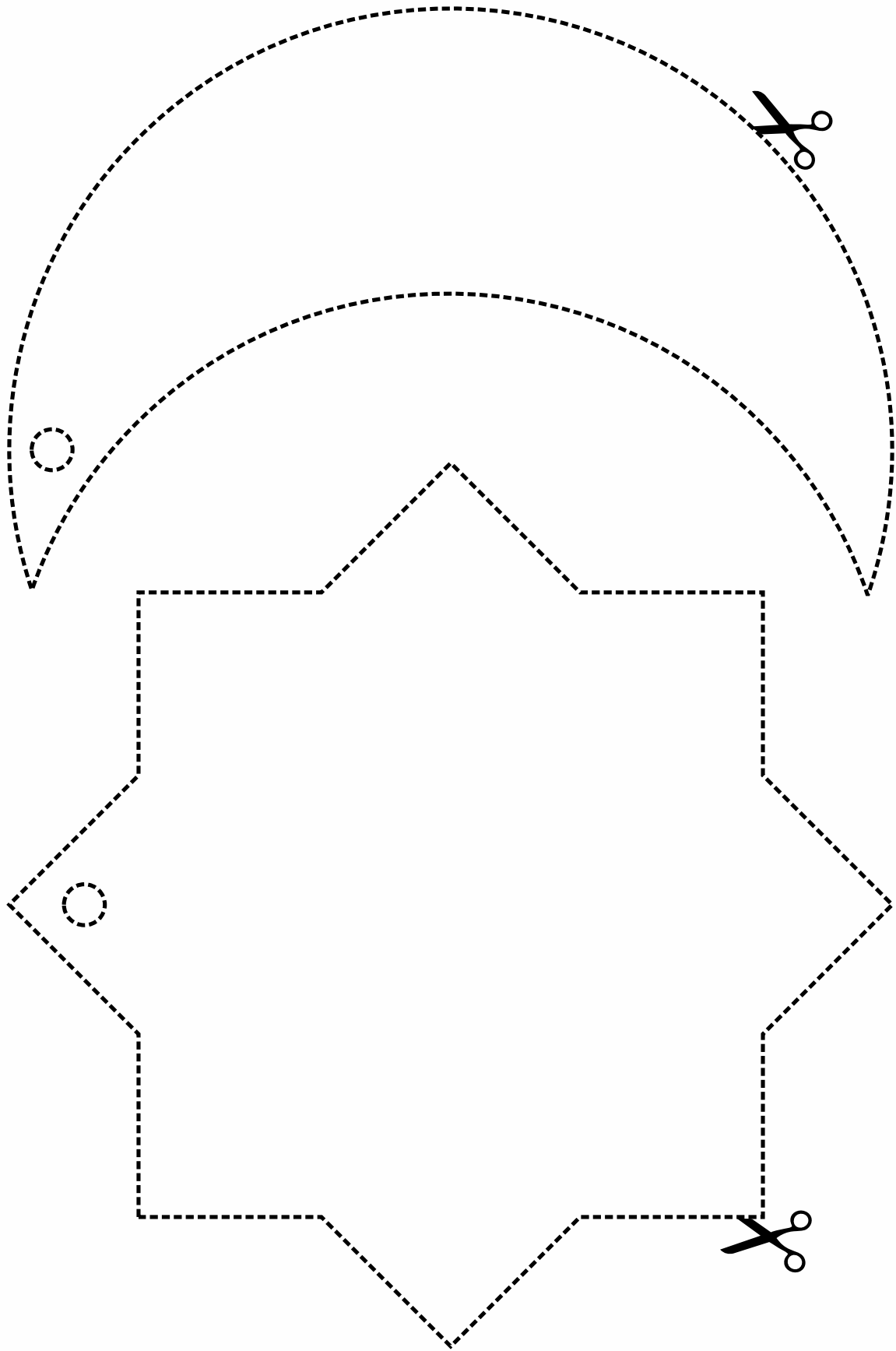

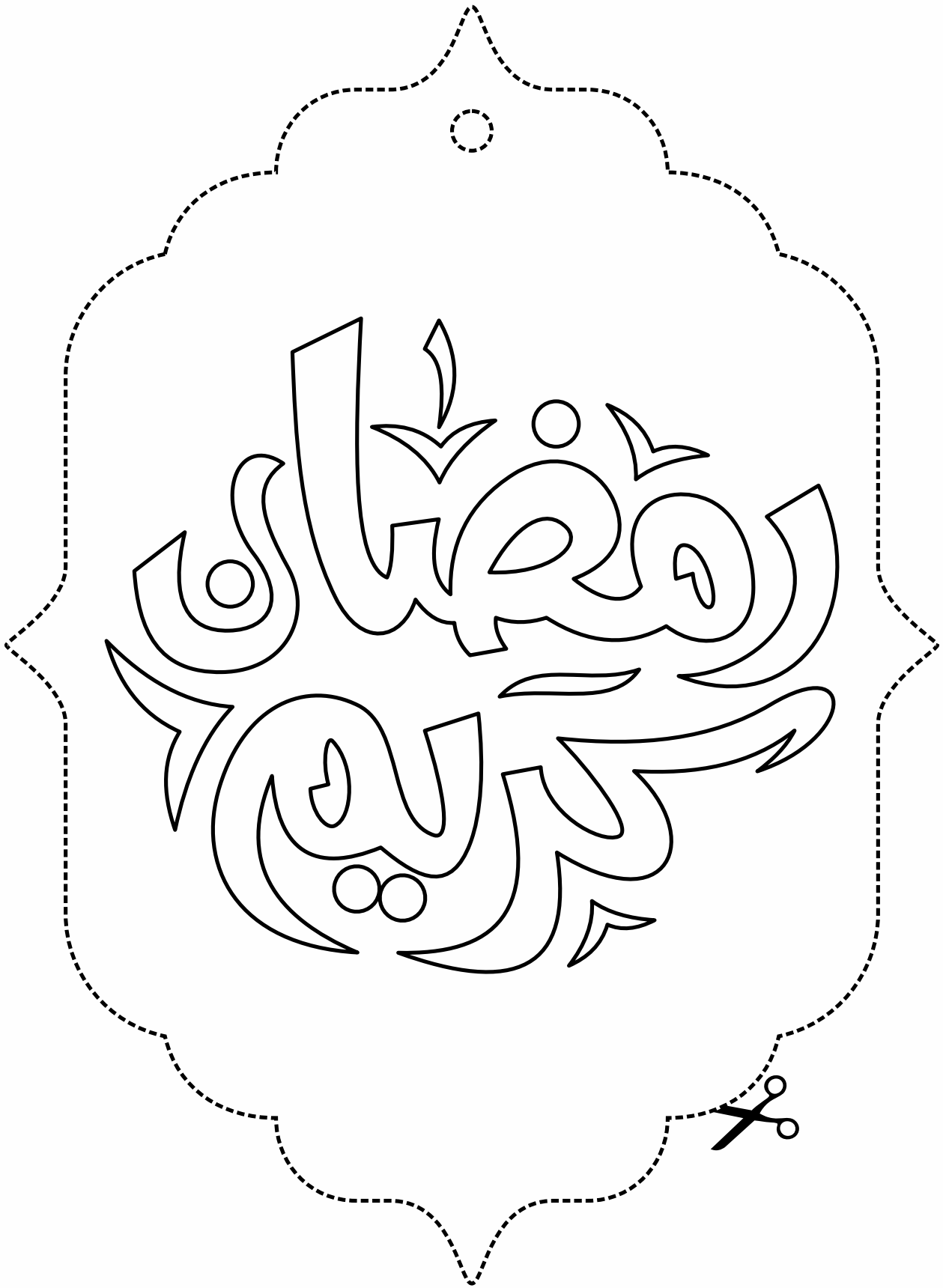



KORKOR TOON
Kids Learning Books

Ramadan
Activities Book



© 2024 KORKORTOON All Rights Reserved
www.korkortoon.com